

## Article

# A Study on Daylighting Performance of Split Louver with Simplified Parametric Control

Muna Alsukkar, Mingke Hu \*, Mohamed Gadi and Yuehong Su \*

Department of Architecture and Built Environment, University of Nottingham, Nottingham NG7 2RD, UK; muna.alsukkar@nottingham.ac.uk (M.A.); mohamed.gadi@nottingham.ac.uk (M.G.)

\* Correspondence: mingke.hu@nottingham.ac.uk (M.H.); yuehong.su@nottingham.ac.uk (Y.S.)

**Abstract:** A split louver consists of two sections with their slat angles to be adjusted separately for glare protection and redirection of sunlight, respectively. The upper section works in conjunction with the lower section to enhance daylight availability and uniformity throughout the year. The study aims to improve the daylighting performance of the split louver by applying a simplified parametric control, which predetermines the angle difference between adjacent slats in the upper section for a chosen solar altitude and then keeps this difference fixed during operation. The slats in the upper section can be changed parametrically using the Grasshopper to reflect daylight onto the ceiling and then illuminate the rear zone of a space. The lower section of the split louver can control the daylight in the front space area and may affect the amount of light in the back. The performance indicator in evaluating the proposed split louver design for the chosen typical days is the percentage coverage of the work plane area for the illuminance range of 150–750 lux, which was achieved up to 100% in some cases. The proposed split louver with the simplified parametric control has the potential to provide relatively consistent and distributed daylight coverage of the floor area and a glare-free environment.

**Keywords:** daylight performance; parametric design; simplified parametric control; split louver

**Citation:** Alsukkar, M.; Hu, M.; Gadi, M.; Su, Y. A Study on Daylighting Performance of Split Louver with Simplified Parametric Control. *Buildings* 2022, 12, 594.

<https://doi.org/10.3390/buildings12050594>

Academic Editor:  
Audrius Banaitis

Received: 31 March 2022  
Accepted: 29 April 2022  
Published: 4 May 2022

**Publisher's Note:** MDPI stays neutral with regard to jurisdictional claims in published maps and institutional affiliations.



**Copyright:** © 2022 by the authors. Licensee MDPI, Basel, Switzerland. This article is an open access article distributed under the terms and conditions of the Creative Commons Attribution (CC BY) license (<https://creativecommons.org/licenses/by/4.0/>).

## 1. Introduction

Daylight is an essential source of energy in buildings. A sufficient amount of daylight increases the visual comfort of its occupants while also lowering the building's energy consumption. Modern buildings are increasingly using highly glazed façades and large windows to provide access to daylight, solar gain, and an external view. Highly glazed façades provide indoor environmental conditions that are frequently visually and thermally unpleasant [1]. A higher level of control over window openings was linked to a better level of satisfaction with overall comfort, temperature, and air quality, while a higher level of control over shading devices was linked to a higher level of lighting satisfaction [2]. According to studies, commercial buildings consume 20–30% of overall energy, whereas office buildings consume 35% of electrical energy [3]. Using daylighting systems in office buildings, on the other hand, can save up to 50% of overall energy use [4]. To reduce the risk of overheating and optimise the use of daylight, highly glazed façades in open-plan offices need the use of regulated dynamic solar shading. However, both manually and automatically controlled shadings normally have the same design in all areas of the window at any given time, regardless of the role they must perform or their position within the window's height [5,6].

Significant potential for energy savings and generation, as well as improved occupant comfort, can be left unexplored by building envelopes. Solar radiation is actively modulated by adaptive solar façades for energy generation, passive heating, shading, and daylight penetration [7]. Since different parts of a window system must perform different

functions, multiple control strategies and shading systems must be used accordingly. Multi-sectional façades that serve various purposes are effective when each section performs one or more of the following tasks: protection from direct sunlight and glare, avoidance of overheating, and proper daylight transmission. Multi-sectional façade solutions can balance daylighting and energy efficiency while maintaining comfort [8]. Various elements, such as characteristics, size, and control of each individual control or shading device and their corresponding operations, should be considered in the design of a multi-sectional façade [8–10].

The position of the shading device system within the window with two sections of upper and lower window areas was previously distinguished in a number of studies [11–14]. Other studies used three sections of top, middle, and bottom, which represent daylighting, viewing, and shading, respectively [5,9]. The upper window section allows for improved light levels in the deep spaces by allowing daylight to pass through. While providing daylight and shading near the window area, the bottom window area also affords a view of the outside. Different areas, specified glazing components, different shading types, and control strategies may be provided in the various sections [8]. To achieve the lighting requirements for glare-free workplaces and to optimise the illumination into the depth of the room, it is necessary to split the shading device on the window into upper and lower sections, in which the front area shouldn't exceed 2000 lux and the back shouldn't be less than 300 lux [1,5,15].

The employment of daylight responsive controls ensures that there are acceptable levels and quality of daylight in interior spaces [16,17]. Advanced daylighting systems often manage to increase indoor daylight quality, particularly for deep spaces, improve daylight uniformity, and control solar heat gains [14,18,19]. The required systems are those that block or redirect solar beams, preferably towards the ceiling, and diffusely redistribute reflected light to the work plane [20,21]. At a specific angle in the upper section, daylight should be redirected toward the interior to maximise daylight distribution deep into the room. The elevation angles of the sun must be considered while designing the shading devices of the multi sectional façade [11,21]. In the winter, the sun shines at a lower angle, whereas in the summer, it shines at a much higher angle. As a result, the slat angle of the shading system must be designed so that low winter sunlight is redirected at a lower angle into the deep area of the room, while high summer sunlight is reflected at a higher angle. To eliminate direct glare, the lowest slat in the upper section somewhat requires a steep angle to redirect the light toward the ceiling [11,22]. According to Osterhaus [23], slat angles for different positions of the shading device can be variable. In general, the optimum slat angle combination of the split shading devices provides the highest illuminance levels at the front and back areas of a space, less, however, than 2000 lux.

A balance between numerous variables, such as solar radiation, orientation, etc., should be considered in order to increase illuminance quality while reducing energy consumption and at the same time using the split louver. Nonetheless, only a few studies have shown an interest in multi sectional window and incorporation of the split shadings. No study has considered different controls of different split shading parameters (such as geometry and material properties, etc.) with their different functions of the different sections, whether in shading or redirecting daylight inside a specific space with a response to the different times of day throughout the year, parametrically.

A new approach is therefore needed for the study of the split louver in different automated controls for its different section functions to deal with multiple variables. Therefore, this study primarily focuses on utilising the advantages of parametric design as a control tool to improve the consistency and distribution of daylight inside the building during working hours at different typical dates throughout the year. The study aims to develop an overarching framework to develop a practical split louver with two sections based on a parametric control in the upper section that plays a role in illuminating the deep areas that respond to variations in the sun's angles of incidence by employing reflective louver systems and presenting a new simplified method for the parametric control by

having a fixed guide of the slat angle for any given time. The most significant advantage of this study is that it can effectively discover the optimum daylighting performance of the proposed split louver for a highly glazed façade using a simple and effective parametric control method that can be applied in a real-world setting.

## 2. Materials and Methods

### 2.1. Model Description

In a virtual office space in Amman, Jordan (latitude 31.9, longitude 35.9), a case study was conducted to investigate the daylighting performance of the proposed split louver system. The base model was created in Grasshopper using Rhinoceros 3D as a platform (see Figure 1). The Ladybug plugin provides the EPW weather data for this location. The model dimensions are 4 m in clear height, 8 m in depth, and 12 m in length, with a fully glazed south façade (single glazing, 6 mm clear glass with 88% visual transmittance). The walls and ceiling were matte white with a typical reflectivity of 80%, while the flooring was a typical grey with a reflectivity of 18% [24]. The split louver system is mounted on the south window and divided into two sections. White matte coatings with 80% and 30% reflectivity were applied to the upper side of the slats in the upper and lower sections, respectively, while the bottom side of the slats was coated with black matte with 0% reflectivity for both sections to absorb any potential scattered light. The slats of the split louver are adjustable and parametrically controlled. The main concept is to rotate the slats to follow the sun path in order to receive more sunlight. The visual comfort is entirely supplied by daylight, which is supposed to be in the range of 750 lux (no excessive daylighting and no glare) to 150 lux (sufficient daylighting and no artificial illumination). However, depending on the design requirements, the building's actual use, and the visual task these values may change [25]. A 750 lux illuminance threshold was stated to provide better visual satisfaction when performing office tasks [26].

The proposed system of the split louver is designed to provide a flexible illuminance range of 150~750 lux with uniform distribution all over the office room. The location in this case study is a hot arid region with dominant clear sky conditions, providing the most favourable natural lighting conditions during working hours [27] and allowing accurate representation in the computer model [28]. Therefore, a standard CIE sky (sunny with direct sun) was considered. An amendable and customisable formula was built into Grasshopper to manage the slats rotation automatically following the sun direction at a given time and date, parametrically. The simulation parameters and model description are shown in Table 1.

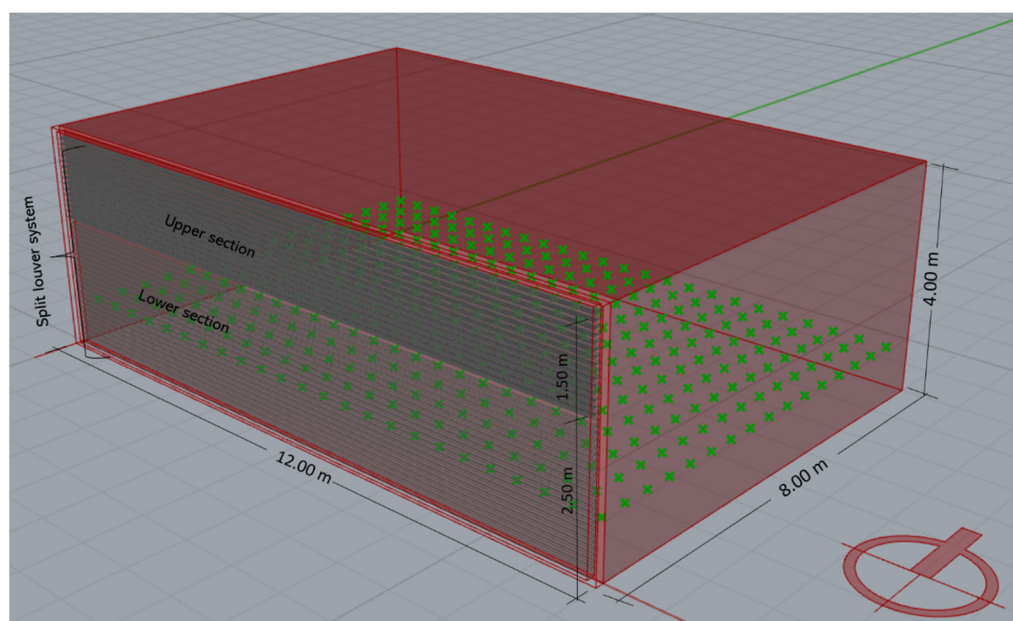


Figure 1. Base model configuration of a virtual office space.

Table 1. Simulation parameters and model description.

Simulation Parameters	Values
Model Dimensions	Width: 12 m, Depth: 8 m and Height: 4 m
Ceiling Reflectance	Typical white matte paint 80%
Wall Reflectance	Typical white matte paint 80%
Floor Reflectance	Typical grey flooring 18%
Work plane Height	0.80 m
Window wall ratio	South window WWR 95%
The split louver system design	(Single glazing, 6 mm clear glass with 88% visual transmittance). Two sections: upper (1.50 m) and lower (2.5 m)
Site location	Amman, Jordan (31.9539° N, 35.9106° E)
Reference Sky type	Standard CIE Sky (Sunny with direct sunlight)

## 2.2. Grasshopper Modelling

The basis of this work is the proposed system of the split louver, which is mounted on the south window of the office space in Rhinoceros using Grasshopper, a visual algorithmic programming language for parametric modelling that may be used as a scripting language to deal with various parameters [29]. According to earlier research, the parametric method might be used to develop several design alternatives for an office building and to evaluate daylighting performance based on a specific location [30]. Grasshopper allows the linking of numerous plugins on one canvas depending on the project requirements. Two specific environmental software plugins were used in this study: Ladybug and Honeybee. The Ladybug plugin is used as an engine to connect Grasshopper to DAYSIM, which is used to obtain weather data for the Amman, Jordan location using the EPW weather file [31]. Meanwhile, the Honeybee plugin is used to connect to “Radiance” software, a lighting simulation analysis tool developed by Ward based on backward ray-tracing method that is used for grid-based solar irradiation and daylighting analysis [32]. Figure 2 illustrates the workflow using Grasshopper and its plugins.

These tools ran the simulations for this study at a specific date and time of 12:00 pm. on 21<sup>st</sup> of March to demonstrate the modelling process precisely. The chosen time corresponds to the equinox, when the sun’s rays have a moderate tendency between the summer and winter solstices. At a later time, the time and date were changed to cover all

probable scenarios of sun exposure and demonstrate the system's applicability and efficiency at various times and dates throughout the year: 21<sup>st</sup> of December and 21<sup>st</sup> of June. These other dates indicate the maximum and minimum sun exposure throughout the year with climatic data for Amman, Jordan's location using EnergyPlus weather file (.epw). Honeybee test points with a 50 cm grid size were used to assess the illuminance level and distribution at the desktop work plane (80 cm above the floor) in the Rhinoceros viewport screen, as seen in Figure 3.

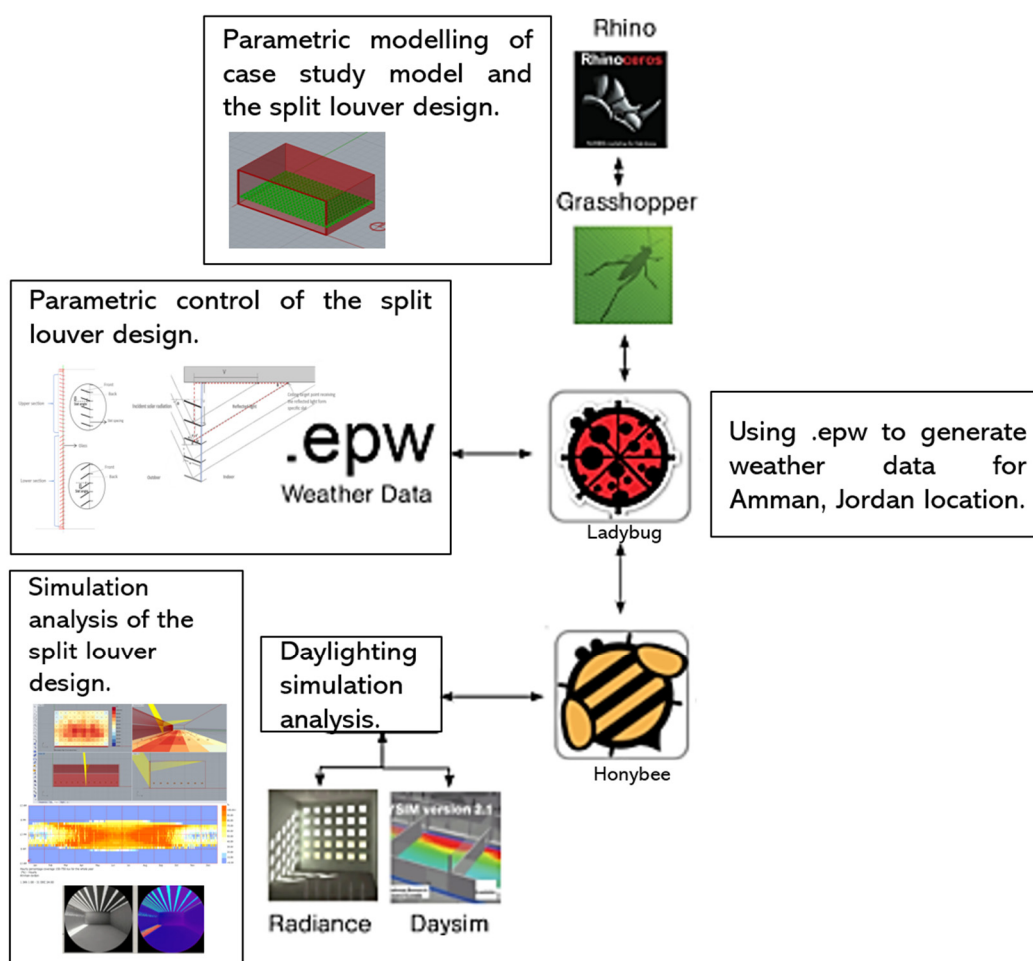
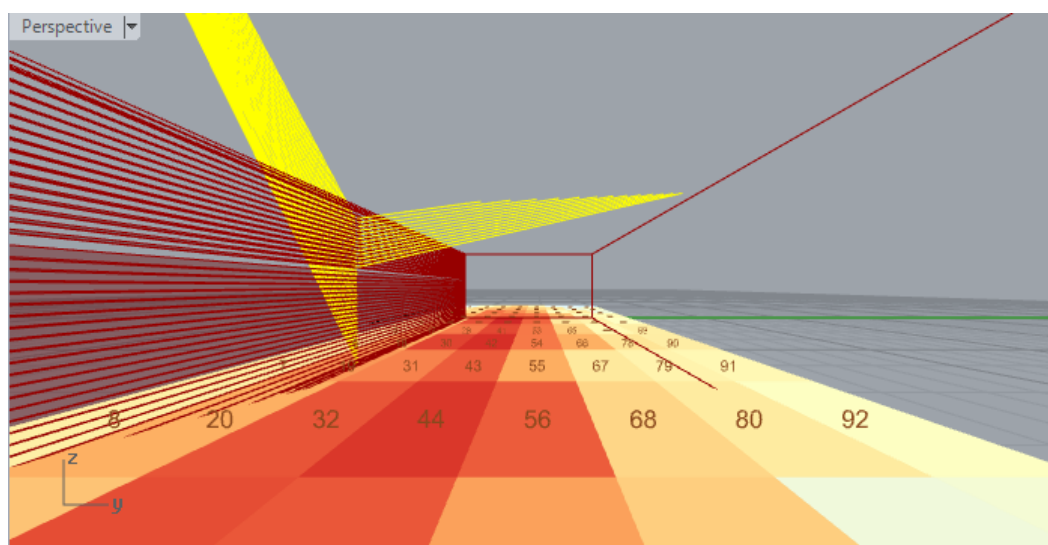


Figure 2. Overview of Ladybug and Honeybee modelling workflow.



**Figure 3.** The model's interior perspective view in the Rhinoceros viewport screen.

### 2.3. Research Design Description of the Split Louver System

#### 2.3.1. Parametric Design of Split Louver

The two sections of the split louver function differently, so their slats have different tilt angles. The upper section's slats are angled toward the inside, directing daylight to the ceiling and deeper into the room to increase the light level, while the slats in the lower section are tilted towards the exterior to prevent glare and overheating. In this study, the mechanism for controlling the upper section used a simplified parametric method. The simpler parametric method with one variable slat angle is considered an improvement over the complicated parametric method with multiple slat angles for each in previous studies [21,33].

The parametric procedure of adjusting the slat angle depends on solar profile angle ( $\Omega$ ) in addition to the vertical and horizontal distances between a slat and a point on the ceiling,  $V$  and  $U$ , respectively. The slat tilt angle ( $\beta$ ) is computed using Equation 1 parametrically by Grasshopper when the time and date are manually changed. The slat angle is established by ensuring that the opposing two angles ( $\gamma$ ) and ( $\gamma'$ ) above the slat are identical, where the first angle is the incidence angle to the slat normal (perpendicular) and the other angle is the intersection of the reflected light and the normal of the slat, regardless of the sun direction. The sun altitude and azimuth, in addition to surface orientation all influence the solar profile angle ( $\Omega$ ) [34–36], which is the vertical angle between the normal to the window and the sun's beams perpendicular to the window plane [37–39]. Figure 4 shows the redirection of sunlight to the ceiling by the rotatable slats with the stated angles.



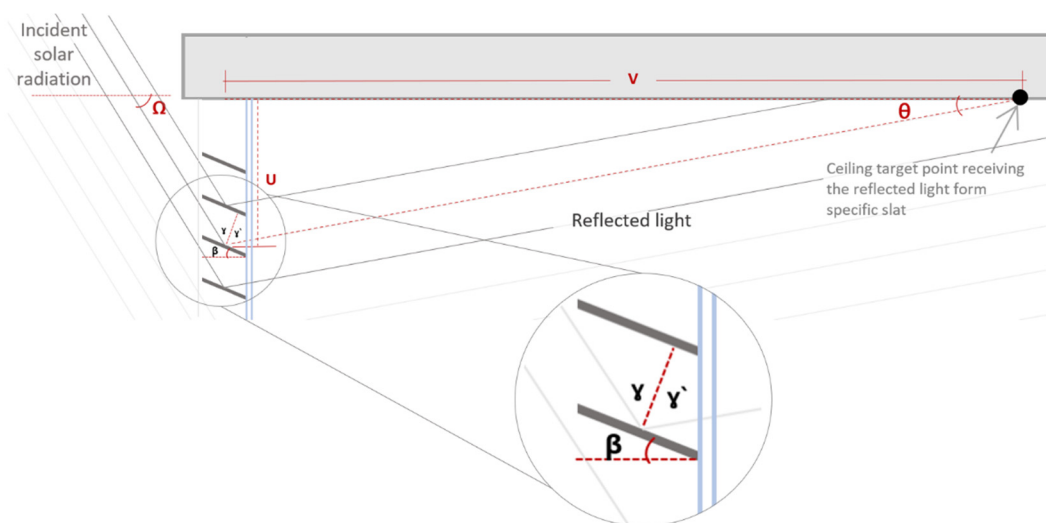


Figure 4. Cross-sectional view of redirection of sunlight to the ceiling by the rotatable slats.

$$\beta = \frac{\Omega - \tan^{-1}(U/V)}{2} \tag{1}$$

where,  $\beta$  is slat angle,  $\Omega$  is solar profile angle,  $U$  is vertical distance between a slat and the ceiling, and  $V$  is horizontal distance between a slat and a point on the ceiling.

The reflected light to certain target areas on the ceiling functions as a light source to illuminate the space to keep the reflected light from the ceiling to the workplace well distributed [33]. The reflected light on the ceiling follows a predictable pattern, with the highest slat reflecting light to the nearest target, the second slat reflecting light to the next adjacent target, and so on. Grasshopper was used to establish particular fixed targets on the ceiling in this study, and the spacing between these targets describes the distance between the centres of reflected beams along the depth of the ceiling. The angle is uniformly divided between the first target, which is near the ceiling edge, and the last target, which is  $\frac{3}{4}$  of the ceiling width away from the deep corner of the room. The room is 800 cm deep, and the targets are evenly spaced, with the first target 200 cm from the window and the last target 40 cm from the ceiling deep corner, as shown in Figure 5.

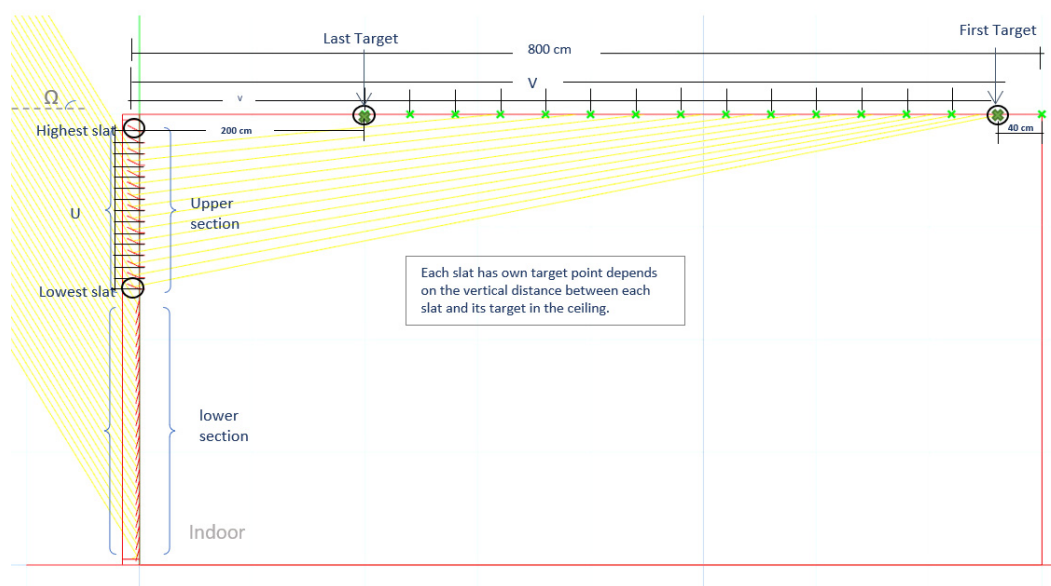
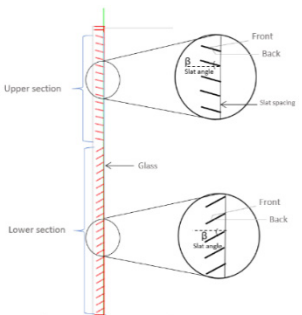


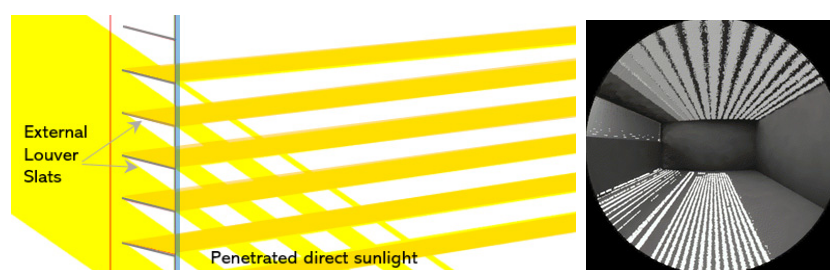
Figure 5. The parametric control of the slat angle, and the fixed targets on the ceiling.

The slat angle is the angle formed by the horizontal plane and the slat plane. The angle is set to zero if the slats are horizontal. If the slats are tilted downward to the exterior, the angle is negative; if the slats are tilted clockwise towards the interior, the angle is positive. The positive angle of the lowest slat in the upper section was set to target the deepest ceiling corner parametrically to avoid any possible glare, while the highest slat was set to target the nearest point to the window. On the other hand, the lower section slats were set to be fully closed ( $-90^\circ$ ) to fully open with a horizontal state ( $0^\circ$ ). The input parameters of the split louver slat in the upper and lower sections are given in Table 2. The proposed split louver system consists of two sections; the upper is 1.5 m and the lower is 2.5 m. The slim slats are 12 cm wide in both sections, and 15 counts in the upper section and 23 counts in the lower section.

**Table 2.** Input parameters for the split louver.

Slat Properties	Values-Upper Section	Values-Lower Section	Split Louver Details
Slat width	12 cm	12 cm	
Slat counts	15	23	
Slat spacing	10 cm	10 cm	
Slat thickness	1 mm	1 mm	
Slat shape	Flat	Flat	
Allowable slat angle range	Parametric angle (the highest slat angle on 21 <sup>st</sup> of June at 12:00 pm is $38.95^\circ$ )	Fully closed ( $-90^\circ$ ) to fully open with horizontal state ( $0^\circ$ )	
Reflectance values	Front: 80% diffuse reflection Back: non-reflective	Front: 30% diffuse reflection Back: non-reflective	

The critical angle beyond which no direct sunlight passes through the slats is known as the cut-off angle. In a previous study [33], the slat counts and spacing were changing corresponding to the altitude in order to create a balance between the cut-off angles. The cut-off angle will not always be achieved using fixed count and width of slats in this study because of the varying sun altitude angle. In order to concentrate primarily on the redirected light's influence, a common blind system was added to the split louver to avoid unnecessary complexity. A comparison test of the daylighting performance of an external louver with and without using attached internal blinds was conducted on 21<sup>st</sup> of December at 12:00 pm. As shown in Figure 6, a direct sunlight penetration can be seen clearly in the workstation area without using the blinds. This proposal is based on a practical and feasible design that uses the same slat parameters such as width, count, and spacing.



(a) Parametric louver without attached blinds



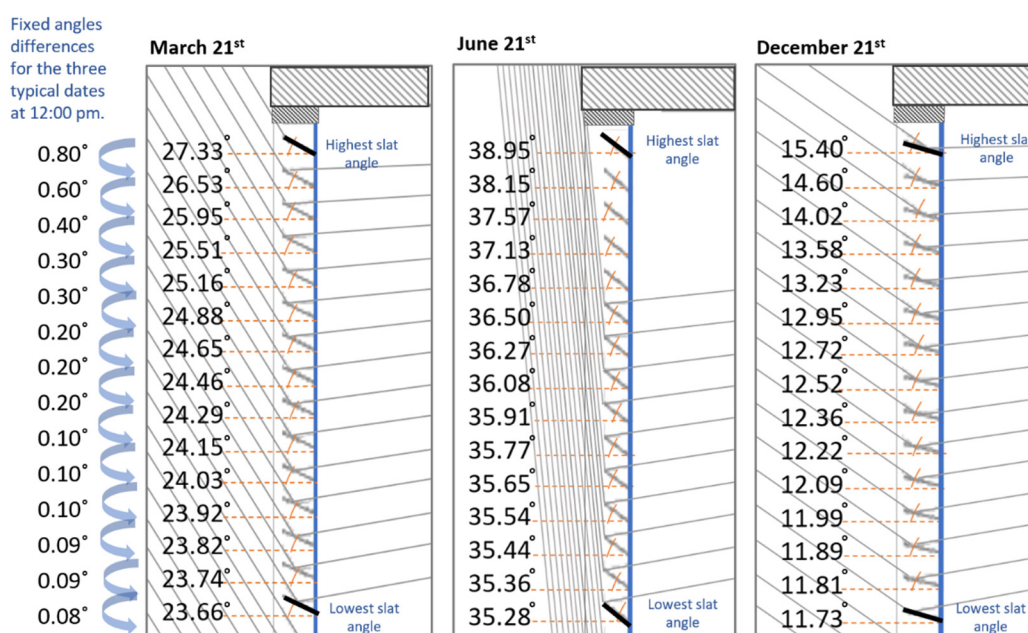


(b) Parametric louver attached with internal blinds.

**Figure 6.** Comparison of light penetration of parametric louver (a) without using blinds and (b) using internal blinds.

### 2.3.2. The Simplified Parametric Control of the Slat Angle

The simplified parametric method basically relies on having a predetermined angle difference between the louver slats for any time of the year. To consider the purpose of practicality, the study assessed the efficiency of the proposed simplified parametric method by testing a split louver with fixed slat width and spacings. The study focused on the variation in incident sunlight on three typical dates, 21<sup>st</sup> of March, 21<sup>st</sup> of June, and 21<sup>st</sup> of December, at 12:00 pm, as presented in Figure 7. The parametric control was applied for these three typical days, and the angle differences between any two adjacent slats were calculated. The relative angles were calculated for the 21<sup>st</sup> of March at 12:00 pm in the first place, then for the other typical dates on the 21<sup>st</sup> of June and 21<sup>st</sup> of December at 12:00 pm. It was successfully discovered that the angle differences between every two adjacent slats were exactly the same values on all typical dates. Consequently, a series of fixed relative angles for the upper section slats was determined. From the lowest slat angle to the highest slat angle, the relative angle differences between each two adjacent slats followed this model series (0.08°, 0.09°, 0.10°, 0.10°, 0.20°, 0.20°, 0.30°, 0.30°, 0.40°, 0.60°, 0.80°). As a result, for the examined model dimensions and the provided location, the relative angle differences between the slats were set to be prefixed at any other time during the year, the simplified parametric control that only relies on prefixed series and one variable slat angle, which is the lowest slat angle of the upper section based on the solar incident angle.



**Figure 7.** The simplified control of the prefixed angle difference for the three typical days.

### 3. Comparative Study and Results

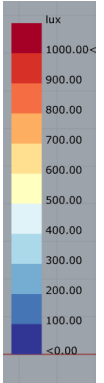
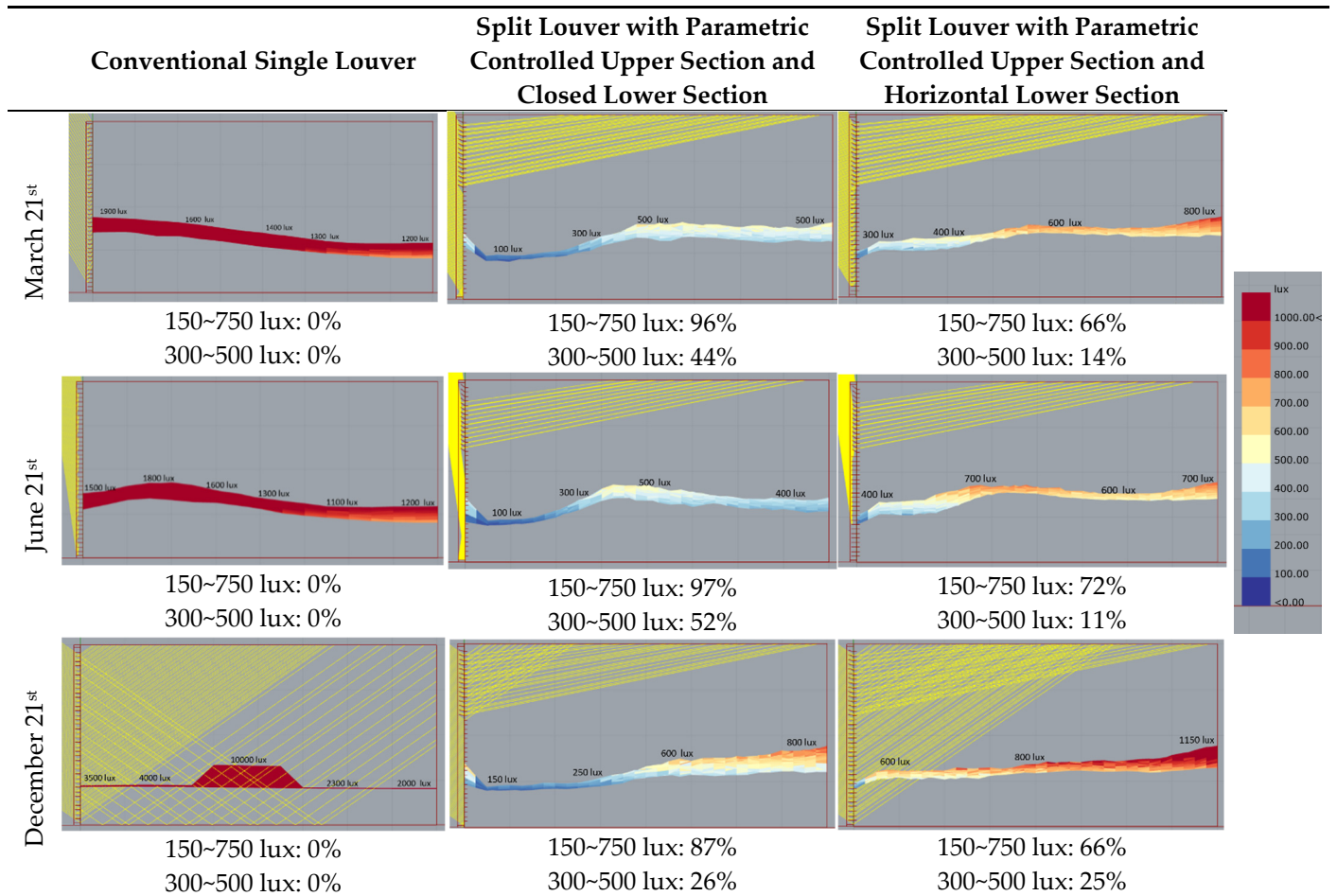
A comparison analysis was conducted between the conventional single and split louver systems at different times on the three typical dates of 21<sup>st</sup> of March, 21<sup>st</sup> of June, and 21<sup>st</sup> of December, which correspond to the highest, equinox, and lowest solar availability during the year. The simplified parametric method was used to control the upper section slats of the proposed split louver. The purpose of using a split louver as a daylighting system is to achieve well-distributed daylight all over the space in both front and back areas within chosen illuminance ranges of 300~500 lux and 150~750 lux.

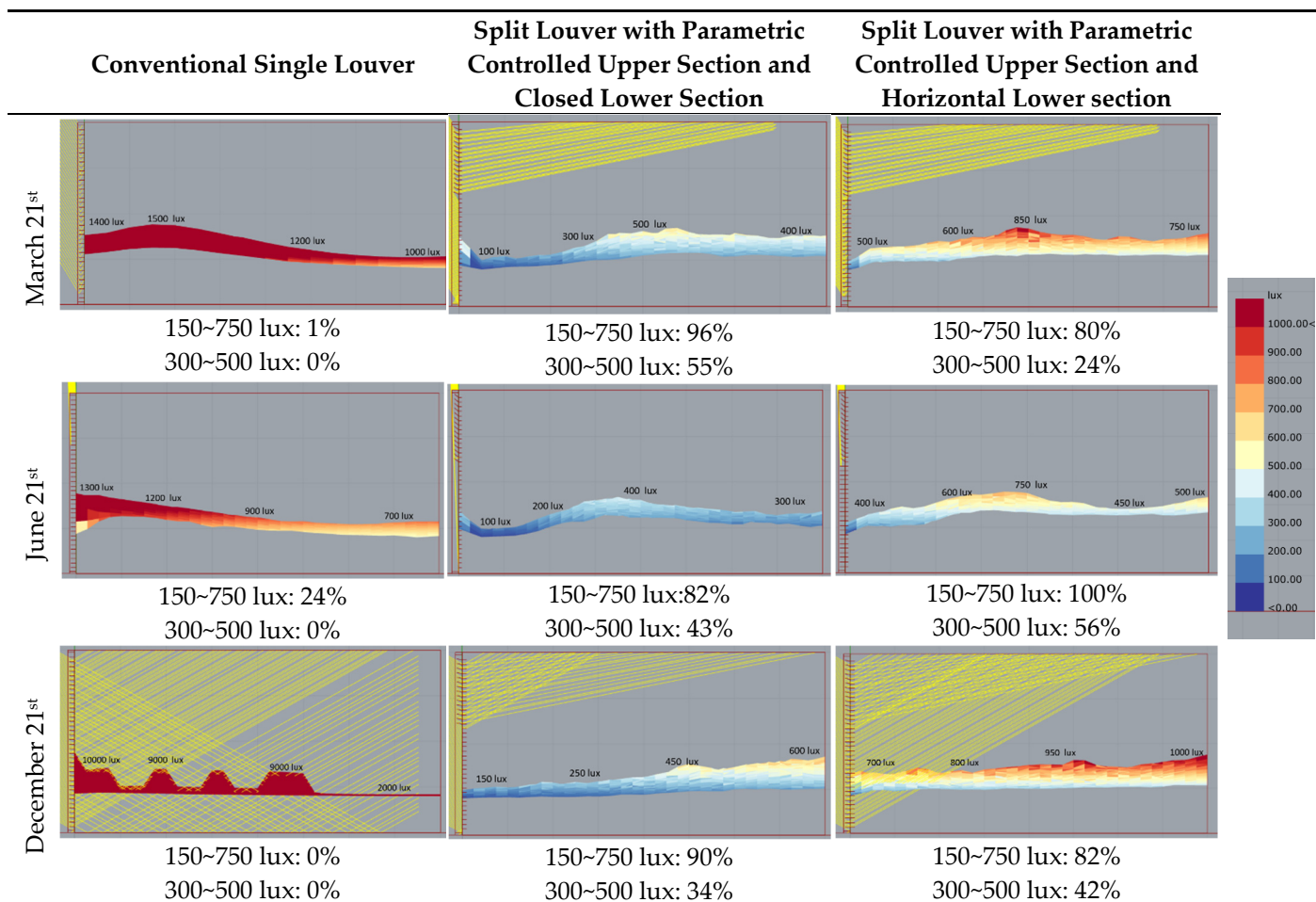
The sectional illuminance distribution graphs in Table 3 show a comparison between conventional single split louver with parametric upper section control and two different lower states (closed and horizontal) at 12:00 pm on three typical dates. The graphs show that the conventional single louver failed to prevent direct incident sunlight from penetrating on 21<sup>st</sup> of December. Furthermore, the provided daylight on the other two typical dates, including December, was not well distributed and showed a lower efficiency in reflecting light in deep spaces in addition to higher illuminance values above 1000 lux, particularly near the window. Due to the low inclination of the sun altitude, the highest average illuminance levels were in December followed by March and then June, causing unpleasant glare.

The parametric control of the split louver's upper section had considerable effects on the three typical dates, and it played a vital role in maximising daylight availability in the deep area of the room while achieving uniform distribution with the help of the lower section to varying extents as shown in Table 3. The daylight performance in March and June was quite comparable, with daylight concentrated in the middle of the working space and higher coverage percentages given within the acceptable specified range. Regarding the performance of the split louver with the parametric upper section and closed lower section at 12:00 pm, from December to June, 150~750 lux coverage ranged from 87% to 97% whereas 300~500 lux coverage ranged from 26% to 52%. The reliance on the fully open lower section resulted in moderate percentages of the chosen daylight coverage ranges at noontime on the three typical dates. The percentage coverage of 150~750 lux decreased to reach 66% to 72% from December to June. Because both sections delivered more sunlight inside between 500 and 750 lux, the 300~500 lux coverage was decreased to between 11% and 25%. Since the slat responded to the sun at a steeper angle in June than on other typical dates, where the slat was exposed to the sun with a limited surface area, less reflected light to the ceiling was produced.

As seen in Table 4, the daylight performance in the morning was comparable to noontime, whereas the conventional system provided higher values beyond 1000 lux, with increased potential of penetrated direct sunlight, which may increase the probability of glare. The split louver also performed similarly to prior analysis and helped to decrease the overall illuminance to reach the desired level of 150~750 and 300~500 lux in both states of the lower section. Changing the lower section state, from closed to horizontally open, the percentage coverage of 150~750 lux increased from 82% to 100% in June, while it decreased in March and December from 96% to 80% and from 90% to 82%, respectively. Due to the lower intensity of solar radiation in the morning hours, the percentages of 300~500 lux were achieved more than at noontime.

**Table 3.** Cross-sectional illumination distribution of conventional single louver and different split louver combinations on the three typical dates at 12:00 pm.



**Table 4.** Cross-sectional illumination distribution of conventional single louver and different split louver combinations on the three typical dates at 9:00 am.

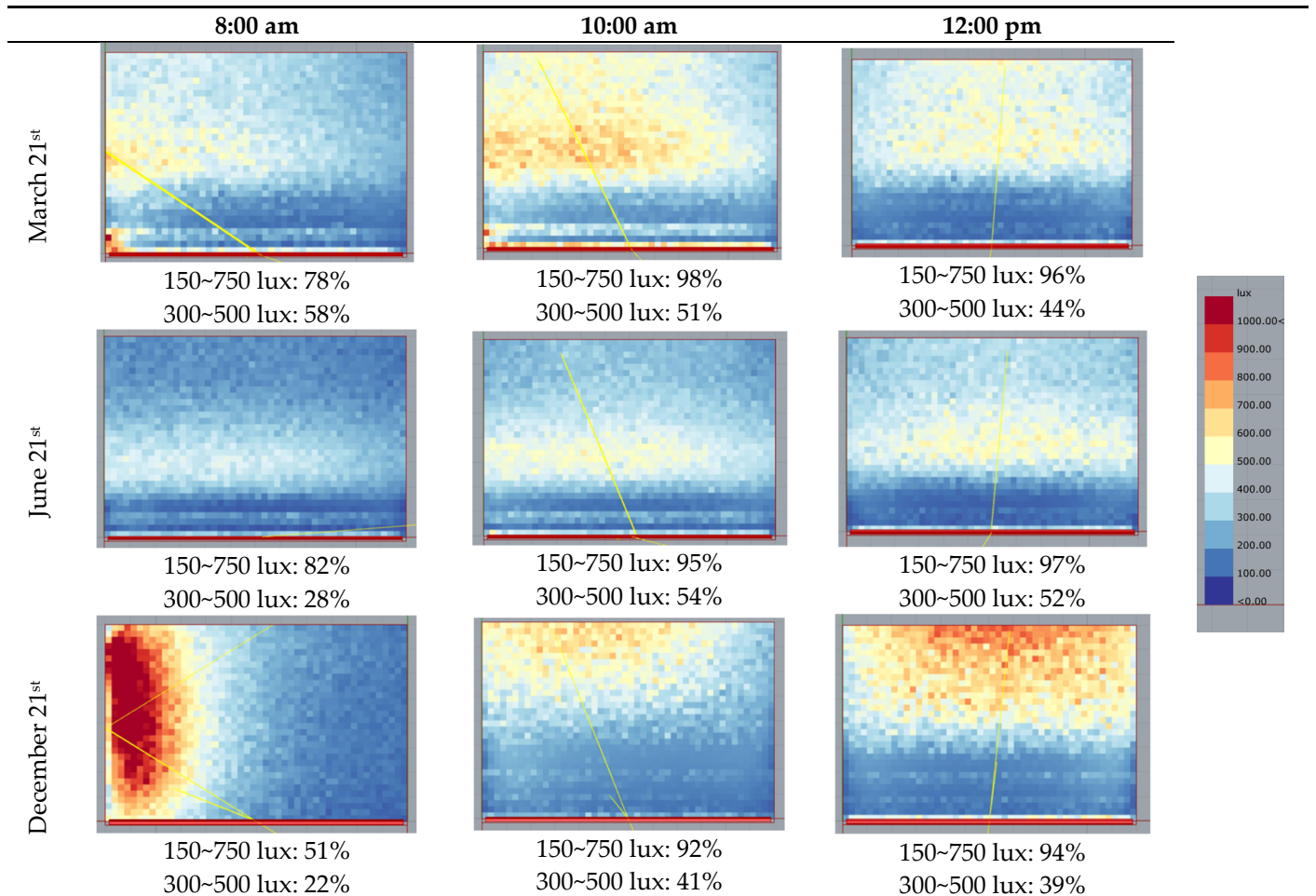
The daylight distribution performance of the proposed split louver with the parametric upper section was also evaluated using floor illuminance maps at the desk level at noontime in Table 5. The difference in performance between the three typical dates can be seen in the reflected light concentration on the work plane, which was more concentrated in deep areas in December and in the middle of the workstation in March and June. However, the distribution of illuminance along the midline concentrated near to the west wall in the morning hours and similar performance for the afternoon hours but the opposite direction near the east wall. As a result, during these hours, directing sunlight to the ceiling is less viable for the system. At the three times in all typical dates, the proposed system with the closed lower section maintained reasonable coverage percentages of the specified range of 150~750 lux with maximum coverage of 97% at 12:00 on 21<sup>st</sup> of June and 98% at 10:00 on 21<sup>st</sup> of March and a minimum percentage of 51% at 8:00 on 21<sup>st</sup> of December.

It is important to examine the variation of lower section influence on daylight performance on the three typical dates at different times while studying the illuminance maps in Table 6. On 21<sup>st</sup> of June and 21<sup>st</sup> of March, the impacts of the open lower section were significant, providing higher percentage coverage of 150~750 lux, especially in the morning hours on 21<sup>st</sup> of June which increased to 100%. At 8:00 am on 21<sup>st</sup> of March, the percentage was also increased from 78% to 94%. However, it had the opposite impact the rest of the time, decreasing the percentages of illuminance range coverage. In the case of the open lower section, it can be seen that the largest illuminance values at all the times were in December due to the low inclination of the sun angle, followed by March then June. Furthermore, due to the extremely low solar angle at early morning of 21<sup>st</sup> of December there was excessive illuminance and penetrative sunlight. These two findings suggest that

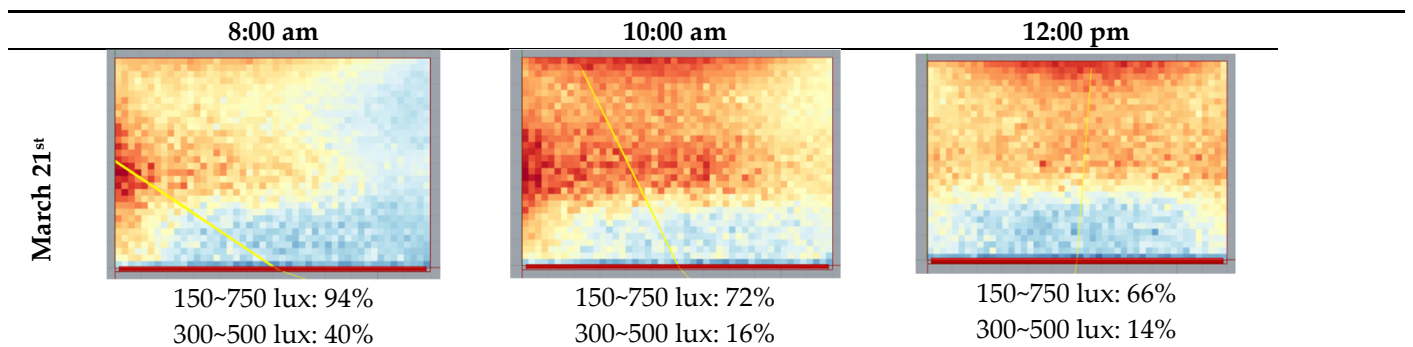


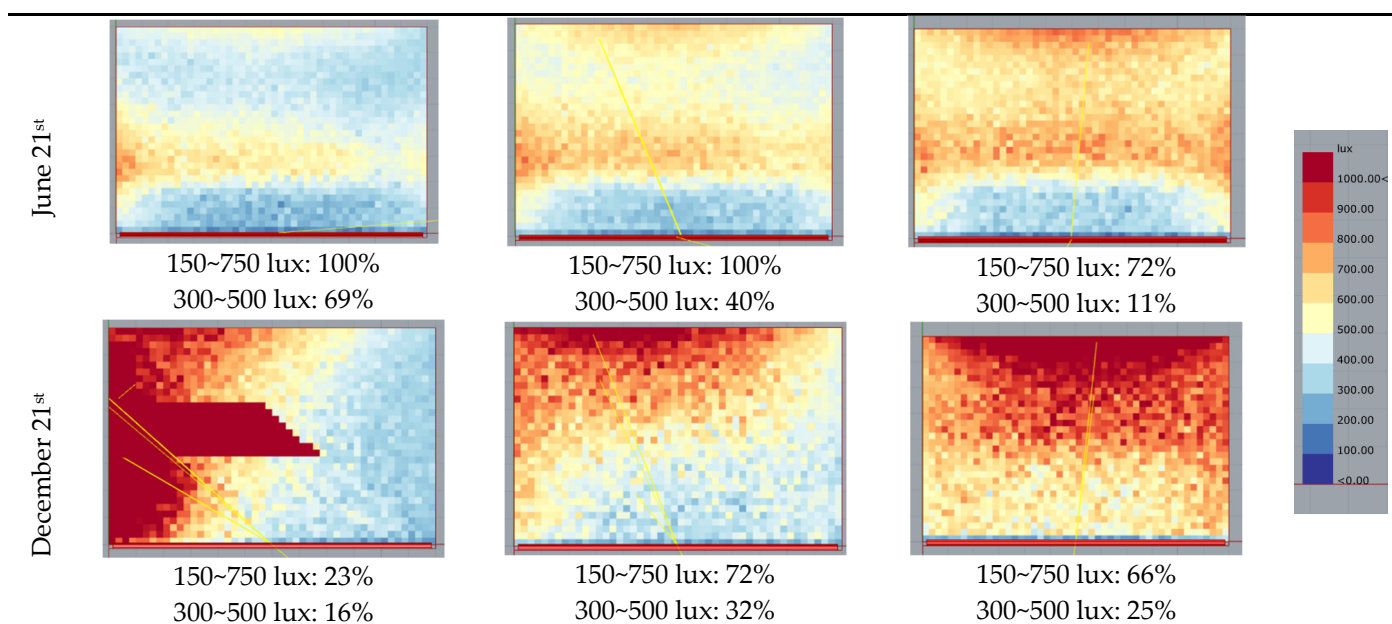
the lower section's influence was more influenced by the lower solar angle. Therefore, the lower section's slats should be properly adjusted according to the sun angle to assist the upper section's parametric slats to maintain the required and evenly distributed illuminance levels.

**Table 5.** Illuminance maps of the proposed system of parametric split louver with a closed lower section on the three typical dates at different three times.



**Table 6.** Illuminance maps of the proposed system of parametric split louver with a horizontal lower section on the three typical dates at different three times.



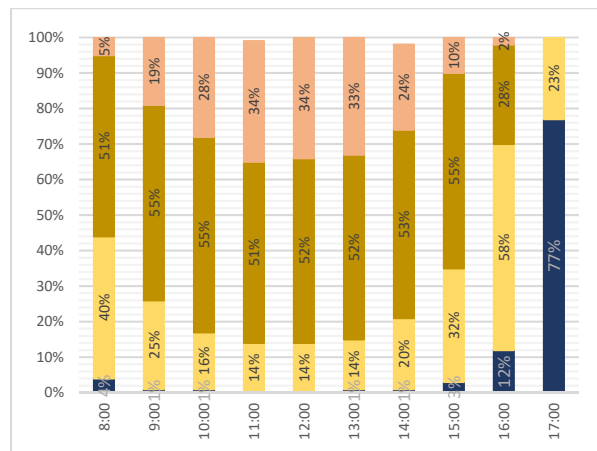
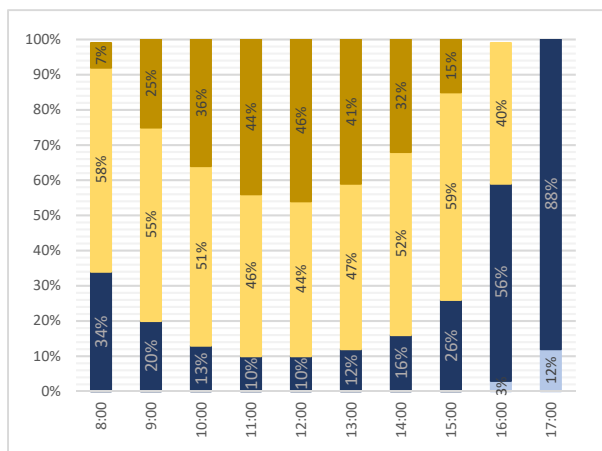


The daylight coverage percentages of different illuminance thresholds of 100, 300, 500, 750, 1000 lux and above were examined and summarised in Table 7 from diagram (a1) to (c2) for the working hours 8:00 am–17:00 pm on the three typical days 21<sup>st</sup> of March, 21<sup>st</sup> of June, and 21<sup>st</sup> of December, respectively. The diagrams showed the split louver system with simplified parametric control in the upper section and two states of closed and horizontally open in the lower section. The horizontally open lower section contributed to increase the illuminance to varying degrees depending on the solar angle and intensity on all typical dates. The coverage range above 1000 lux was not achieved on both 21<sup>st</sup> of March and 21<sup>st</sup> of June, and the percentages of 300 lux to 750 lux were increased, while the range under 300 lux was decreased. The percentages of 750~1000 lux increased on 21<sup>st</sup> of June and 21<sup>st</sup> of March around midday, notably in March. Similarly, on 21<sup>st</sup> of December, the overall illuminance was increased when the lower section was set to be horizontally open to achieve lower percentages under 500 lux, while simultaneously increasing the percentages above 750 lux during all working hours. The solar penetration between the lower section slats was caused by the extremely low solar angle, resulting in a percentage coverage of over 1000 lux.

A summary of daylight coverage percentages of 150~750 lux range for working hours on the three typical dates for the split louver with simplified parametric control of the upper section and the two scenarios of the lower section (closed and horizontally opened) is presented in Figure 8. The fully open lower section functioned differently depending on the date and time of day. It increased the acceptable illuminance range in the morning and afternoon on 21<sup>st</sup> of June, and it increased these ranges in the early morning and early afternoon on 21<sup>st</sup> of March. The percentages decreased slightly around noontime on 21<sup>st</sup> of March and significantly during the day on 21<sup>st</sup> of December.

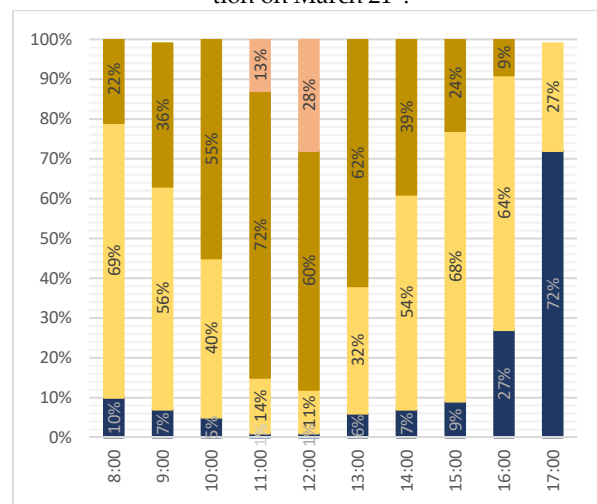
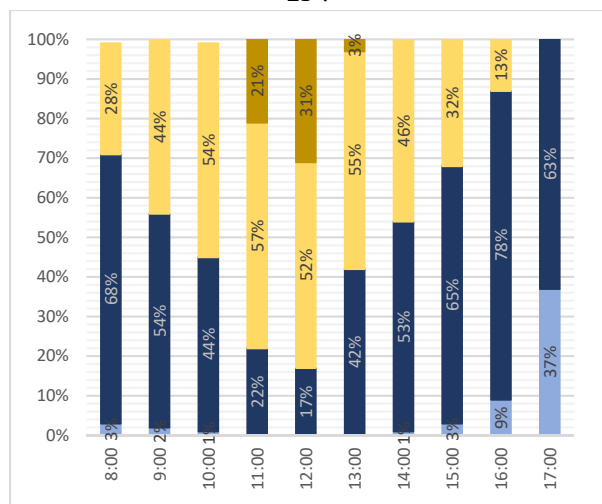


**Table 7.** Daylight coverage percentages of different illuminance threshold 100, 300, 500, 750, 1000 lux and above for the working hours on the three typical days.



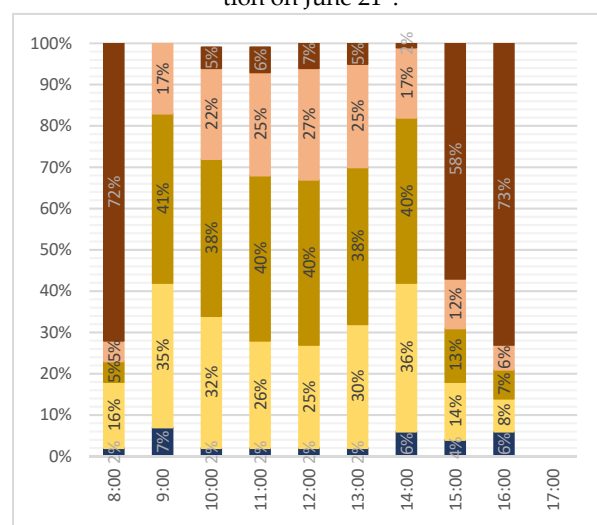
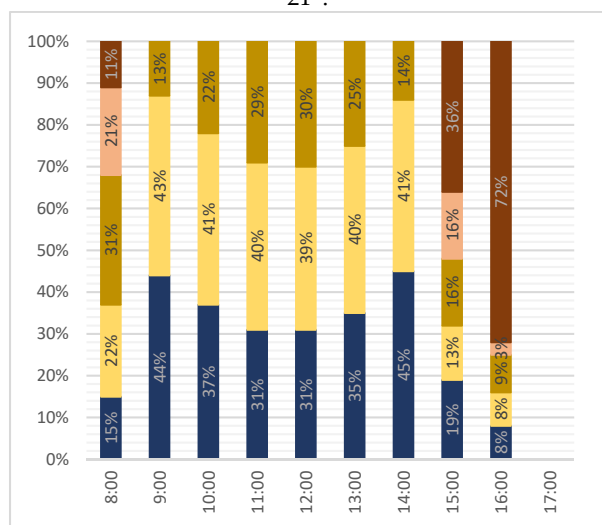
(a1) Parametric upper section and closed lower section on March 21<sup>st</sup>.

(a2) Parametric upper section and horizontally open lower section on March 21<sup>st</sup>.



(b1) Parametric upper section and closed lower section on June 21<sup>st</sup>.

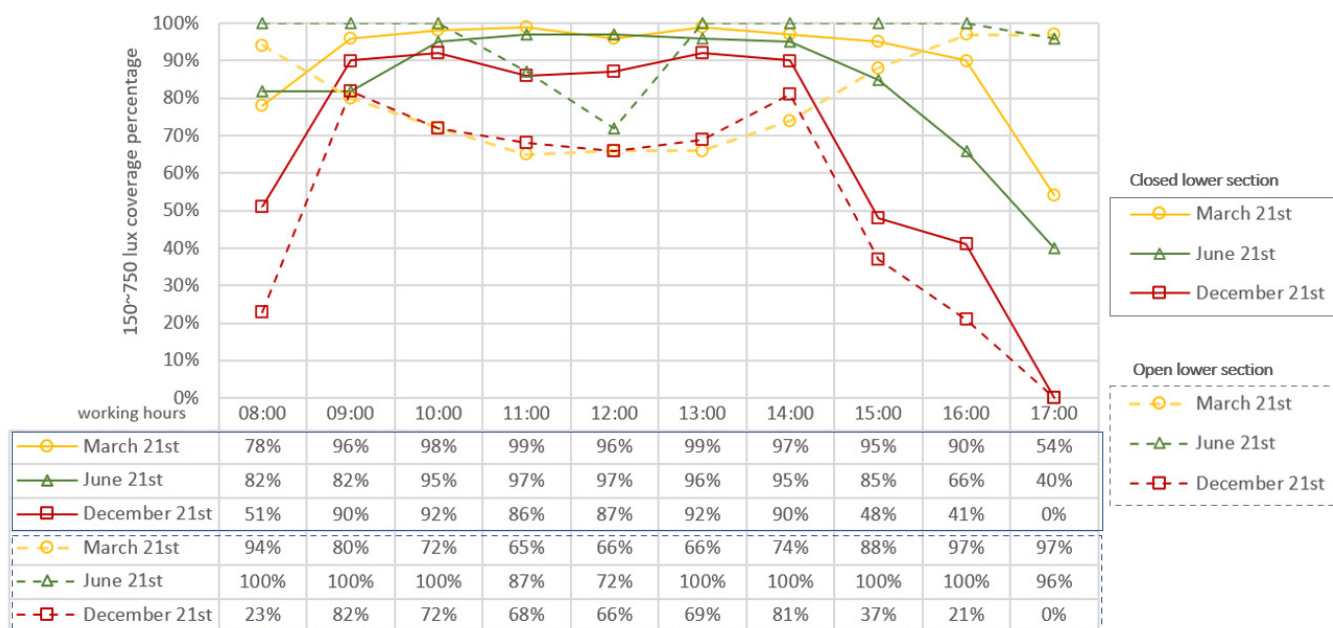
(b2) Parametric upper section and horizontally open lower section on June 21<sup>st</sup>.



(c1) Parametric upper section and closed lower section on December 21<sup>st</sup>.

(c2) Parametric upper section and horizontally open lower section on December 21<sup>st</sup>.

0~100 lux    100~300 lux    300~500 lux    500~750 lux    750~1000 lux    >1000 lux

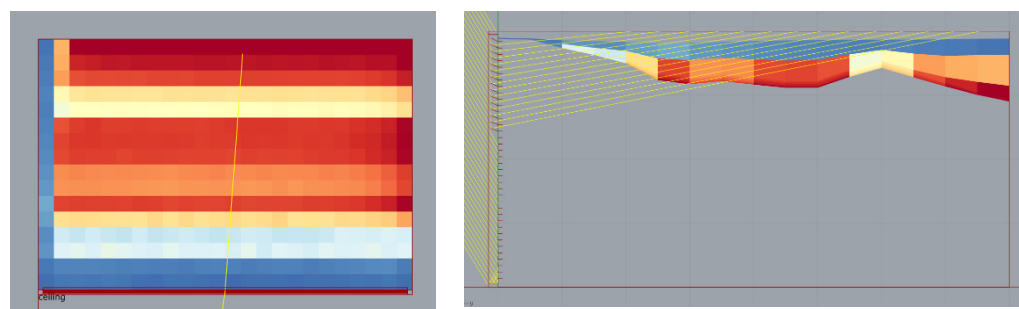


**Figure 8.** The daylight coverage percentages of 150~750 lux of the proposed split louver system for the working hours 8:00 am–17:00 pm on the three typical dates.

#### 4. Discussions

Two aspects of the automated parametric split louver should be highlighted: the behaviour of each section regardless of automation control, and the difference between simplified parametric and full parametric control. Since the simplified parametric method was used as a practical alternative method to control the slats in the upper section in the split louver, a comparison between the full parametric and the simplified parametric approach for the three typical dates was presented. The comparison was done through investigating the behaviour of specular reflective slats in illuminating the floor through reflecting the sunlight toward the ceiling. These reflections can be seen as patches on the ceiling that act as a secondary light source to illuminate the floor. Figure 9 illustrates the illuminance maps of the ceiling and cross-sectional light distribution. The ceiling illuminance maps in Table 8 show that the reflected light striking the ceiling surface appears to be exceptionally similar. The reflection patch sequence was also similar in terms of patch location, with minor differences in the brightness level of some stripes, but this had no effect on the workstation daylight level and distribution. However, light distribution on the ceiling is not the main purpose. In addition, the false colour fisheye maps show that the reflected light on the ceiling as a second bounce results in a darker area on the floor, indicating that the reflected light is more concentrated on the horizontal area in both cases. Overall, the findings demonstrated that both control methods had similar daylight performance. However, using the simplified parametric control is more practical.

It is worth stating that on the three typical dates, the distribution of light on the ceiling had different patterns. In March and December, the light reflected on the ceiling is more consistent and uniform, affecting the uniformity of daylight distribution on the workstation. In June, the sunbeam does not directly strike the south window due to its high inclination. As a result, the relative lack of daylight inside the space might be explained by the steepness of incident light, while in December the sun inclination resulted in producing a small parametric tilt angle; therefore, the slat surface was exposed to the direct sun producing sufficient reflected light on the ceiling.

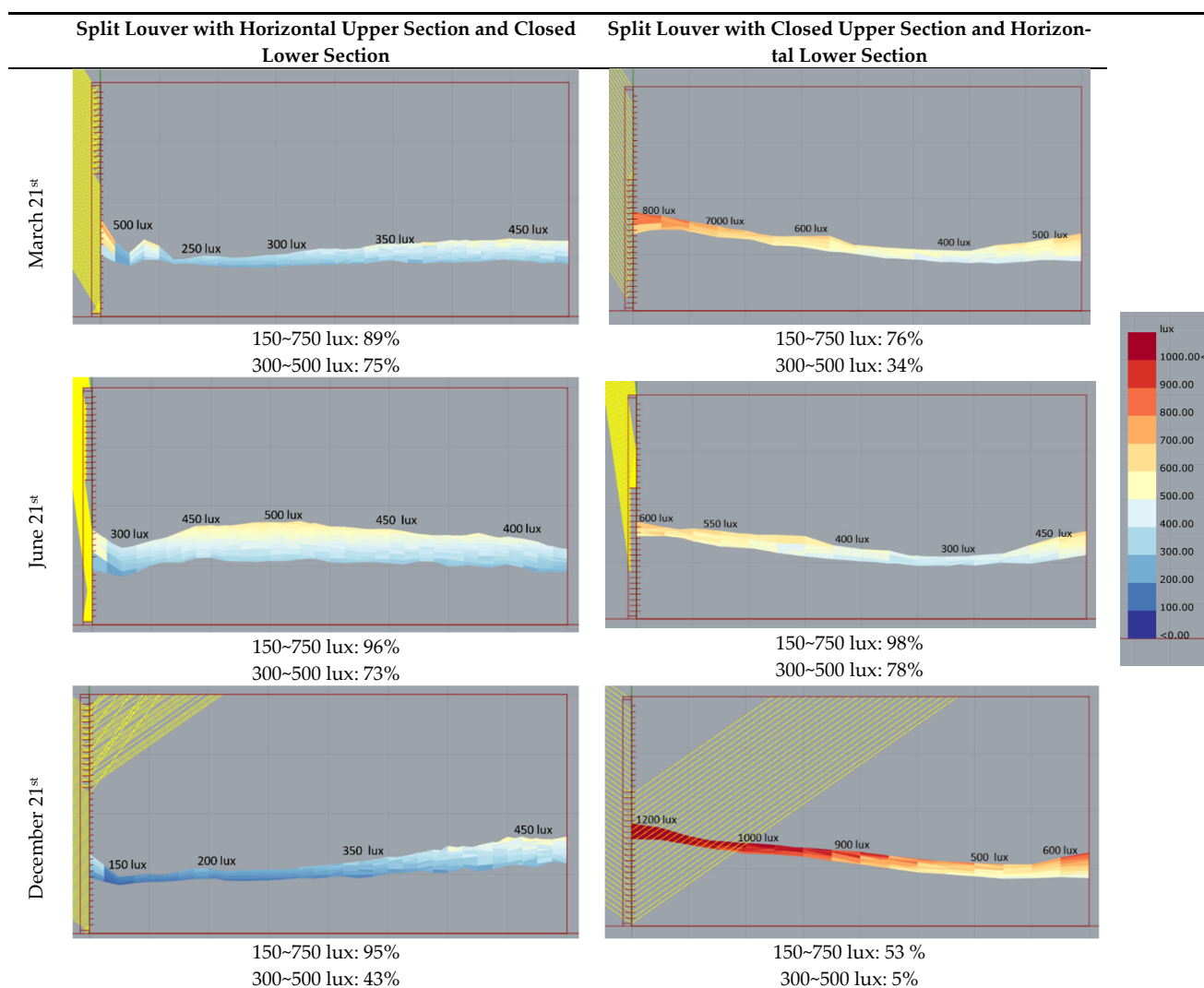


**Figure 9.** Ceiling Illuminance map (right) and cross-sectional illuminance distribution (left) of the specular reflective parametric split louver.

**Table 8.** Comparison between the parametric and simplified parametric controls on different three typical dates at 12:00 pm (Ceiling Illuminance maps and Radiance Fish-eye map).

	Parametric Control (Multiple Variable Slat Angles)		Simplified Parametric Control (One Variable Slat Angle)		
March 21 <sup>st</sup>					
June 21 <sup>st</sup>					
December 21 <sup>st</sup>					

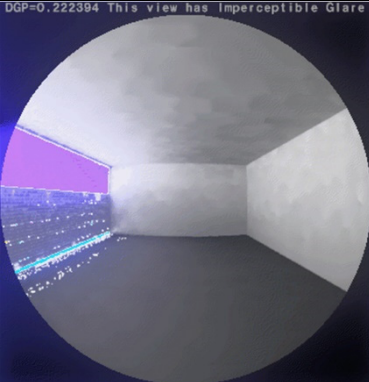

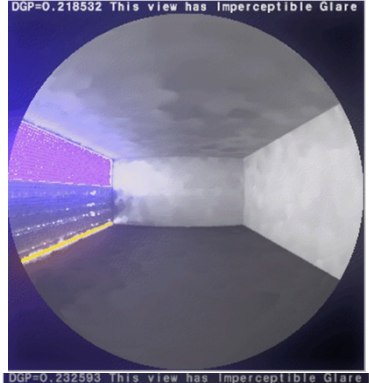
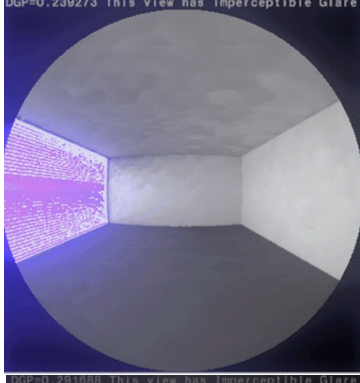
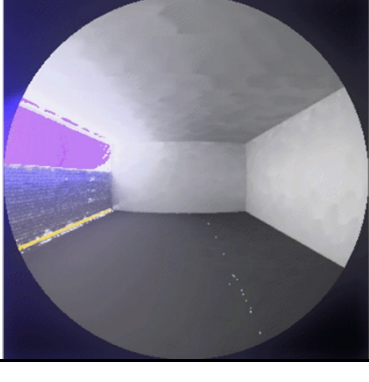
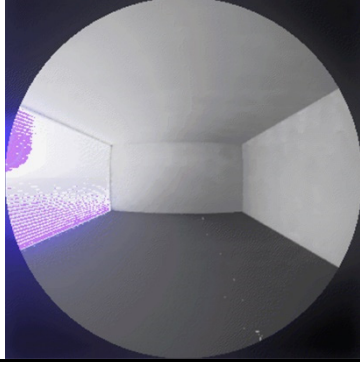
The daylighting performance of the split louver is certainly different depending on the state of each section; so, to understand the performance of both sections independently, an analysis of the split louver through altering the closure state of each section was conducted. The sectional illuminance distribution graphs in Table 9 show alternate closure states for the upper and lower sections. According to these graphs on all typical dates, the back area of the space was more influenced when the upper section was open. The front area near the window, on the other hand, was significantly more illuminated when the lower section was open at all typical dates, particularly in December. These findings confirm the notion that the upper and lower sections have a different impact on daylight distribution in the space’s front and back areas, and they are in line with previous studies. The lower percentages of illuminance ranges on 21<sup>st</sup> of December support the assumption that the lower section has a bigger impact in the case the lower solar angle.

**Table 9.** The behaviour of upper and lower sections in the split louver independently.

As the desktop level illuminance increases to 750 lux, the sensation of glare may increase [26]. Therefore, glare potential analysis was conducted to assess the visual comfort inside the space using the proposed split louver system. The term “DGP” stands for Daylight Glare Probability, which affects the occupants’ visual comfort in the office room [4,23,40]. Glare is defined as the effect of bright light sources diminishing contrast within a visual field, or a difference between a dark and a bright area, or even light reflected from a shiny surface [41]. The field of view, the background luminance, excessive daylight, and material reflectance are all factors that determine how discomfort glare is for a person in space [42]. In order to evaluate the daylight comfort level of the indoor space, Daylight Glare Probability (DGP) is selected for assessing discomfort glare. The DGP results were separated into four bins: lower than 0.35 is ‘imperceptible’ glare sensation; between 0.35 and 0.40 is ‘perceptible’; between 0.40 and 0.45 is ‘disturbing’; and higher than 0.45 is considered ‘intolerable’ [41]. DGP was measured at the desk level for the proposed split louver with two cases of the lower section case (open and closed) for the three typical dates in Table 10. When the lower section was closed, DGP values dropped significantly, which is considered acceptable for visual comfort on all typical days with a value of 0.23 or less, which is considered imperceptible glare. DGP values in December increased to 0.29 when the lower section was completely open with the horizontal state, which is considered imperceptible glare. The DGP values increased, but still at the same rating of imperceptible in June and March, which is still considered acceptable for visual comfort.



**Table 10.** The glare potential analysis (DGP) of the split louver.

	Split Louver with Parametric Upper Section and Closed Lower Section	Split Louver with Parametric Upper Section and Horizontal Lower Section
March 21 <sup>st</sup>		
June 21 <sup>st</sup>		
December 21 <sup>st</sup>		

## 5. Conclusions

This study has evaluated the application of a simplified parametric control to improve the daylighting performance of a split louver. The simplified parametric control is a more practicable measure, applying a pre-determined angle difference between adjacent slats in the upper section of a split louver and then employing a single rotation angle for this set of slats. This gives a much simpler operation than a fully parametric control with individual slat rotation angles. The angle difference between adjacent slats in the upper section is determined parametrically only for one solar altitude at 12:00 pm on 21<sup>st</sup> of March.

A comparative experiment in modelling has been undertaken between the conventional single and split louver systems for three typical days in Amman, Jordan as a case study location. Several combinations of split louver were studied using the simplified parametric control in the upper section and altering the lower section state.

The calculation confirms such angle differences can be adopted for other dates. In comparison with the conventional single louver, the two sections of a split louver influence the daylight distribution in the front and back of the room differently. In addition to

daylight distribution analysis, performance indicators such as percentage coverage of the work plane area for illuminance ranges of 150–750 lux and 300–500 lux were investigated. In the morning and afternoon on 21<sup>st</sup> of June, for example, the stated illuminance range of 150–750 lux was increased to 100%. The parametric design of the slat angles in the upper section of a split louver provides a more uniform illuminance level in the back of the space with a comfortable glare free environment. The illuminance level can be manually controlled by adjusting the slat angle in the lower section of the split louver. The lower section of a split louver is primarily for shading, and its operation largely affects the daylight illuminance in the front of a room, particularly at low solar altitudes. It is critical to coordinate two sections of a split louver to maximise the overall daylighting performance over a whole year period.

**Author Contributions:** The authors have contributed equally. All authors have read and agreed to the published version of the manuscript.

**Funding:** This research received no external funding.

**Institutional Review Board Statement:** Not applicable.

**Informed Consent Statement:** Not applicable.

**Acknowledgments:** This research is supported by a PhD studentship funded by the Hashemite University, Jordan.

**Conflicts of Interest:** The authors declare no conflict of interest.

## Reference

1. Konis, K.; Selkowitz, S. *Effective Daylighting with High-Performance Facades: Emerging Design Practices*; Springer: Berlin/Heidelberg, Germany, 2017.
2. Pastore, L.; Andersen, M. The influence of façade and space design on building occupants' indoor experience. *J. Build. Eng.* **2022**, *46*, 103663.
3. Mardaljevic, J. Daylight, indoor illumination and human behavior. IN: Meyers, R.A. (ed.) *Encyclopedia of Sustainability Science and Technology*. New York: Springer, pp. 2804–2846.
4. Konstantoglou, M.; Tsangrassoulis, A. Dynamic operation of daylighting and shading systems: A literature review. *Renew. Sustain. Energy Rev.* **2016**, *60*, 268–283.
5. Olbina, S.; Hu, J. Daylighting and thermal performance of automated split-controlled blinds. *Build. Environ.* **2012**, *56*, 127–138.
6. Olbina, S. Split controlled blinds as a thermal and daylighting environmental control system. The 3rd CIB International Conference on Smart and Sustainable Built Environments (SASBE2009), Delft, Netherlands, 2009.
7. Svetozarevic, B.; Begle, M.; Jayathissa, P.; Caranovic, S.; Shepherd, R.F.; Nagy, Z.; Hischer, I.; Hofer, J.; Schlueter, A. Dynamic photovoltaic building envelopes for adaptive energy and comfort management. *Nat. Energy* **2019**, *4*, 671–682.
8. Chan, Y.-C.; Tzempelikos, A. Daylighting and energy analysis of multi-sectional facades. *Energy Procedia* **2015**, *78*, 189–194.
9. Do, C.T.; Chan, Y.-C. Evaluation of the effectiveness of a multi-sectional facade with Venetian blinds and roller shades with automated shading control strategies. *Sol. Energy* **2020**, *212*, 241–257.
10. Do, C.T.; Chan, Y.-C. Daylighting performance analysis of a facade combining daylight-redirecting window film and automated roller shade. *Build. Environ.* **2021**, *191*, 107596.
11. Köster, H. *Dynamic Daylighting Architecture: Basics, Systems, Projects*; Springer Science & Business Media: Berlin/Heidelberg, Germany, 2004.
12. Kim, J.-H.; Park, Y.-J.; Yeo, M.-S.; Kim, K.-S. An experimental study on the environmental performance of the automated blind in summer. *Build. Environ.* **2009**, *44*, 1517–1527.
13. Rhee, K.-N.; Jung, G.-J. Evaluation of Indoor Environment and Energy Performance with Slat Adjustment Method of Split Blinds. *Journal of Korean Institute of Architectural Sustainable Environment and Building Systems*. **2020**. 401–413. <https://doi.org/10.22696/jkiaeb.20200034>.
14. Nabil, A.; Mardaljevic, J. Useful daylight illuminance: A new paradigm for assessing daylight in buildings. *Lighting Res. Technol.* **2005**, *37*, 41–57.



15. Ruck, N.; Aschehoug, O.; Aydinli, S. Daylight in Buildings—A source book on daylighting systems and components. *Lawrence Berkeley Natl. Lab.* **2000**, 9910–47493. <http://www.iea-shg.org> or <http://gaia.lbl.gov/iea21/>.
16. Andersen, D.; Foldbjerg, R. *Daylight, Energy and Indoor Climate—Basic Book*. VELUX Knowledge Centre for Daylight, Energy and Indoor Climate (DEIC) A/S; 2012. [http://www.velux.com/~media/com/articles/pdf/deic\\_basic\\_book\\_ver%203-0.pdf](http://www.velux.com/~media/com/articles/pdf/deic_basic_book_ver%203-0.pdf)
17. Littlefair, P.; Aizlewood, M.; Birtles, A. The performance of innovative daylighting systems. *Renew. Energy* **1994**, *5*, 920–934.
18. Köster, H. Daylighting controls, performance and global impacts. *Sustainable Built Environment*. Springer, New York, NY. 2013 *1*, 112–162. [https://doi.org/10.1007/978-1-4614-5828-9\\_198](https://doi.org/10.1007/978-1-4614-5828-9_198).
19. Wienold, J.; Frontini, F.; Herkel, S.; Mende, S. Climate based simulation of different shading device systems for comfort and energy demand. In Proceedings of the 12th Conference of International Building Performance Simulation Association, Sydney, Australia, 14–16 November 2011.
20. Mandalaki, M.; Tsoutsos, T. *Solar Shading Systems: Design, Performance, and Integrated Photovoltaics*; Springer: Berlin/Heidelberg, Germany, 2020.
21. Eltaweel, A.; Yuehong, S. Using integrated parametric control to achieve better daylighting uniformity in an office room: A multi-Step comparison study. *Energy Build.* **2017**, *152*, 137–148.
22. Köster, H. *Daylighting Controls, Performance, and Global Impacts*, in *Sustainable Built Environments*, V. Loftness, Editor. 2020, Springer US: New York, NY. p. 383–429.
23. Osterhaus, W.K. Discomfort glare assessment and prevention for daylight applications in office environments. *Sol. Energy* **2005**, *79*, 140–158.
24. Eltaweel, A.; Su, Y.; Hafez, M.; Eltaweel, W. An automated louver with innovative parametrically-angled reflective slats: Prototyping and validation via using parametric control in Grasshopper along with Arduino board. *Energy Build.* **2021**, *231*, 110614.
25. Sicurella, F.; Evola, G.; Wurtz, E. A statistical approach for the evaluation of thermal and visual comfort in free-running buildings. *Energy Build.* **2012**, *47*, 402–410.
26. Lee, J.-H.; Moon, J.W.; Kim, S. Analysis of occupants' visual perception to refine indoor lighting environment for office tasks. *Energies* **2014**, *7*, 4116–4139.
27. Freewan, A.A. Impact of external shading devices on thermal and daylighting performance of offices in hot climate regions. *Sol. Energy* **2014**, *102*, 14–30.
28. Freewan, A.A.; Shao, L.; Riffat, S. Interactions between louvers and ceiling geometry for maximum daylighting performance. *Renew. Energy* **2009**, *34*, 223–232.
29. Lagios, K.; Niemasz, J.; Reinhart, C.F. Animated building performance simulation (ABPS)—linking Rhinoceros/Grasshopper with Radiance/Daysim. *Proc. SimBuild* **2010**, *4*, 321–327.
30. Eltaweel, A.; Yuehong, S. Parametric design and daylighting: A literature review. *Renew. Sustain. Energy Rev.* **2017**, *73*, 1086–1103.
31. Roudsari, M.S.; Pak, M.; Smith, A. Ladybug: A parametric environmental plugin for grasshopper to help designers create an environmentally-conscious design. In Proceedings of the 13th International IBPSA Conference, Lyon, France, 26–28 August 2013.
32. Kharvari, F. An empirical validation of daylighting tools: Assessing radiance parameters and simulation settings in Ladybug and Honeybee against field measurements. *Sol. Energy* **2020**, *207*, 1021–1036.
33. Eltaweel, A.; Su, Y. Controlling venetian blinds based on parametric design; via implementing Grasshopper's plugins: A case study of an office building in Cairo. *Energy Build.* **2017**, *139*, 31–43.
34. Kim, C.-H.; Lee, K.-H.; Kim, K.-S. Evaluation of Illuminance Measurement Data through Integrated Automated Blinds and LED Dimming Controls in a Full-Scale Mock-up. *Energies* **2020**, *13*, 3238.
35. Chan, Y.-C.; Tzempelikos, A. A hybrid ray-tracing and radiosity method for calculating radiation transport and illuminance distribution in spaces with venetian blinds. *Sol. Energy* **2012**, *86*, 3109–3124.
36. Chan, Y.-C.; Tzempelikos, A. Efficient venetian blind control strategies considering daylight utilization and glare protection. *Sol. Energy* **2013**, *98*, 241–254.
37. Lechner, N. *Heating, Cooling, Lighting: Sustainable Design Methods for Architects*; John Wiley & Sons: Hoboken, NJ, USA, 2014.
38. Wang, Y.; Chen, Y.; Guo, X.; He, W.; Gao, L. Development of a solar control method of the venetian blinds. *Procedia Eng.* **2015**, *121*, 1186–1192.
39. Yu, X.; Su, Y. A discussion of inner south projection angle for performance analysis of dielectric compound parabolic concentrator. *Sol. Energy* **2015**, *113*, 101–113.

40. Eltaweel, A.; Su, Y.; Mandour, M.A.; Elrawy, O.O. A novel automated louver with parametrically-angled reflective slats; design evaluation for better practicality and daylighting uniformity. *J. Build. Eng.* **2021**, *42*, 102438.
41. Wienold J. Dynamic daylight glare evaluation. *Proceedings of Building Simulation - Eleventh International IBPSA Conference, Glasgow, Scotland, 944–951, 2009.*
42. Bodart, M.; Cauwerts, C. Assessing daylight luminance values and daylight glare probability in scale models. *Build. Environ.* **2017**, *113*, 210–219.