

Experimental study of enclosure airtightness of an outdoor chamber using the pulse technique and blower door method under various leakage and wind conditions

Xiaofeng Zheng^{*1}, Joe Mazzon², Ian Wallis², Christopher J Wood¹

*1 Building, Energy and Environment Research Group,
Faculty of Engineering, University of Nottingham
University Park, Nottingham NG7 2RD, UK*

*2 BSRIA Limited
Old Bracknell Lane West
Bracknell, Berkshire, RG12 7AH, UK*

ABSTRACT

This paper introduces an experimental study of enclosure airtightness testing of an outdoor chamber using both the pulse technique and the blower door method. This investigation is a 2nd stage comparison study following the previous testing of a house-sized chamber in a sheltered environment. The outdoor chamber in this study has dimensions, approximately half that of a standard 20ft long shipping container. Multiple openings were installed into the chamber's envelope to provide a leakage level and characteristics similar to an average UK house. Two sets of experimental tests were carried out independently at different times to investigate: a) How the pulse technique and blower door method compare on measuring enclosure airtightness of an outdoor chamber at various leakage levels; b) How the steady wind at various wind speed affects the measurement of chamber airtightness using the pulse technique.

The comparison tests were performed in the chamber with various leakage levels achieved by sealing up different vents. Both blower door and pulse have given comparable results ($\pm 16\%$) of air permeability at 4 Pa in most testing scenarios, which is a slightly larger discrepancy than that found in the previous sheltered environment study. In the steady wind tests, the external fabric of the chamber was subjected to wind at various wind speed levels, by utilising a multi-gear portable trailer fan. Initial findings have shown that the impact of steady wind on the measurement of chamber airtightness using the pulse technique is mostly insignificant when it is under 3.5 m/s. The measured air permeability at 4 Pa (P4) at high wind speed (4 m/s - 9.5 m/s) in one direction is 16%-24% less than that measured under fan off condition in the steady wind tests

KEYWORDS

Enclosure airtightness, Blower door, PULSE unit, outdoor environment, chamber

1. INTRODUCTION

1.1. Context

As a well-known and widely accepted steady pressurisation method for measuring building air leakage, the blower door method makes measurements in a range of high pressures, typically 10-60 Pa. It is implemented by creating a steady pressure difference, either negative or positive, across the building envelope and measuring the corresponding airflow exchange rate between the indoor and outdoor simultaneously. The air leakage result is quoted at an elevated pressure difference, compared to the ambient i.e. 50 Pa in order to reduce the impact of wind and buoyancy effects. The novel pulse technique, developed to measure the building air leakage at low pressures typically in the range of 1-10 Pa, is implemented by rapidly releasing a known volume of air from a compressed air tank into the test building, thereby creating an instantaneous pressure rise that quickly reaches 'quasi-steady' conditions. The underlying principle is that of a quasi-steady flow, which can be shown to exist via the temporal inertial model and further detail is given by Cooper (Cooper 2007 and Cooper 2014).

The pressure variations in the building and tank are monitored and used for establishing a correlation between leakage and pressure. The building air leakage result is quoted at low pressure, i.e. 4 Pa which is regarded as a typical weather-induced pressure level (Sherman 2004). This paper presents two separate investigations; firstly a comparison study, in which both methods were used to measure the envelope airtightness of an outdoor chamber where the environmental condition is not protected against. This forms part of a continued study of investigation following on from the previous reporting of experimental testing, which compared the measurements of enclosure airtightness in a sheltered environment [Zheng 2017]. This study aims to provide insight into how the comparison between testing methods varies in the unsheltered environment. The second investigation in this study looks into how steady wind would affect the pulse test. These two investigations are named herein as the NC (natural condition) test and the SW (steady wind) test, respectively.

1.2. Equipment

The main blower door unit used in this study is a Duct Blaster B (DBB), manufactured by ‘The Energy Conservatory’ in the United States. It consists of an adjustable door frame, flexible canvas panel, a variable-speed fan, and a DG700 pressure and flow gauge, as shown in Figure 1. The DBB is designed to provide smaller air flow and is therefore used for testing alongside the Pulse technique. For one NC test a larger Energy Conservatory DB-2 blower door was also used for a single comparison. For all the NC tests a prototype PULSE-80 unit was used, which consisted of an 80-litre lightweight composite tank and oil free double piston compressor as shown in Figure 2. Due to equipment availability a different pulse unit was used in the SW testing. The PULSE-60 unit, used, incorporates a 60 litre lightweight aluminium tank and oil free compact air compressor as shown in Figure 3. The pulse data (chamber pressure and tank pressure) is recorded and analysed by the control box and results are displayed on the LCD screen of the control box.

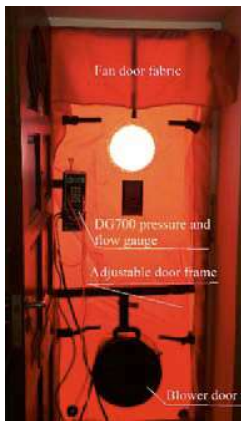

Figure 1 Energy Conservatory Duct blaster B (DBB)



Figure 2 PULSE-80 and associated control box (NC test)

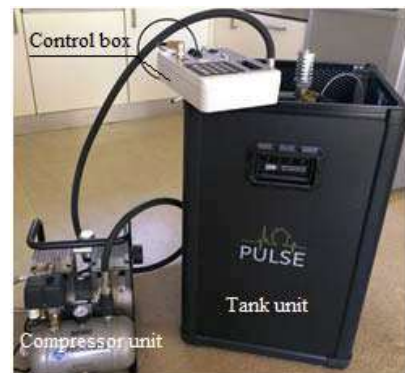

Figure 3 PULSE-60 and associated control box (SW test)

In the SW test, a multi-gear portable trailer fan was used to provide various wind conditions for testing. The fan is driven by a petrol engine and various fan speeds were achieved by the combination of three different gears and fan speed controller, as shown in Figure 4.



Figure 4 a petrol driven multi-gear portable trailer fan

1.3. Chamber

A chamber, improvised from a standard 20-foot (6.1m) long shipping container and located in the vicinity of an office building, was divided to two separate spaces by a partition wall. One of them, highlighted in by a blue rectangle in Figure 5, was used for testing. The chamber, with dimensions of 2.84m×2.23m×2.03m, was installed with background openings in order to provide leakage level that is present in typical domestic buildings. The outdoor chamber used in this testing was utilised due to availability and access which enabled various wind speeds to be introduced. It must be noted however that this chamber is smaller than that used in (Zheng 2017).



Figure 5 External chamber for comparative testing

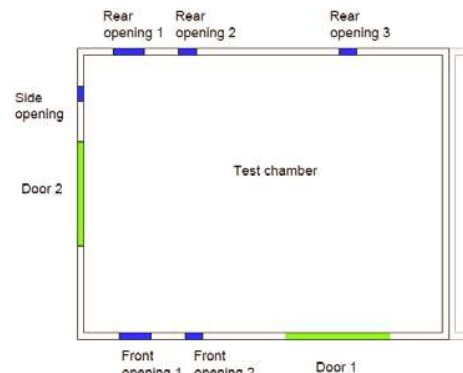















Figure 6 Plan of openings in the test chamber

Figure 6 shows the chamber plan with various openings around the envelope. Overall, there are 14 openings. Each opening location given in Figure 6 represents one or multiple openings at different heights of external walls. Table 1 provides a photograph for each particular opening, at each plan location. These are shown in the table from top to bottom according to their relative physical height. The converted shipping container, fabricated from sheet steel is inherently air tight compared to typical wall construction of buildings, therefore three deliberate vents (opening R1-1) are utilised to provide a typical ‘background’ leakage to the enclosure. It must be noted that the NC and SW tests were carried out with one year gap in-between, during which the chamber had been used for multiple projects with changes made to the enclosure. Hence it could not be assured that chamber leakage would be the same for both scenarios and therefore the NC and SW are not compared.

Table 1 Openings in the test chamber envelope

Plan Location:	Rear opening 1	Rear opening 2	Rear opening 3	Front opening 1	Front opening 2	Side opening
Highest ↑ Height at individual plan location ↓ Lowest	 R1-1: Background vents  R1-2: Combustion air opening	 R2-1: Passive stack ventilator  R2-2: Open flued boiler	 R3-1: Kitchen extraction vent  R3-2: Sink U bend  R3-3: Toilet U bend	 F1-1: Humidity controlled trickle vent  F1-2: Manually controlled trickle vent  F1-3: Cat flap	 F2: Static vent (behind radiator)	 S-1: Shower extract vent  S-2: Tumble drier vent  S-3: Static vent

2. NATURAL CONDITION (NC) TESTS

2.1 Testing arrangement

Leakage levels were achieved by sealing up various openings, to achieve 6 testing scenarios as shown in Table 2, thus providing a wide spectrum of leakage characteristics.

Table 2 Openings sealed in various scenarios for the NC tests (Opening ID's as listed in Table 1)

Scenario	1	2	3	4	5	6
NC test	All except R1-1	All except R1-1 and R1-2	All except R1-1, R1-2, S-3, F2	All except R1-1, R1-2, S-3, F2, F1-1, F1-2, R3-2, R2-2, S-2, R2-1	All unsealed	All sealed except R1-1 and R2-2
Descriptor	Compliance test: All openings were sealed except background vents	Air brick unsealed	Radiator vent and static vent unsealed	Trickle vents, sink traps, boiler vent, dryer vent and passive stack vent unsealed	Bathroom vent, cooker extract and shower vent unsealed	All openings were sealed except background vents and boiler vent

The DBB was installed in door 2 (See figure 6) and the PULSE-80 unit was placed in the centre of the chamber. The setup of the DBB and PULSE-80 unit is shown in Figure 7 and Figure 8. The chamber enclosure was prepared according to the ATTMA (the Air Tightness Testing & Measurement Association) technical standard L1 albeit with various sealing arrangements of openings as per table 2. In scenario 1, DBB tests were carried out in both pressurisation and depressurisation modes and repeated three times alongside the pulse test. In the other scenarios, only one pressurisation test, (except for scenario 6, with 3 pressurisation tests) was performed due to time constraint.



Figure 7 Setup of blower door



Figure 8 Setup of PULSE unit

2.2 NC Test results

Table 3 shows P4 measured by the DBB and PULSE-80 unit under 6 different scenarios, with the chamber preparation of each scenario described accordingly.

Table 3 P4 (m³/h·m²) of the chamber measured by DBB and PULSE-80 under various scenarios

Scenario	1			6		2	
	DBB Pressurise	DBB Depressurise	PULSE-80	DBB Pressurise	PULSE-80	DBB Press'	Pulse -80
1	4.34	4.31	4.21	4.71	4.46	5.51	4.86
2	4.40	4.36	3.84	5.20	4.44		
3	5.10	4.53	4.33	5.55	4.53		
Mean	4.61(±10.5%)	4.40(±3.0%)	4.13(±6.9%)	5.15(±8.6%)	4.48(±1.2%)		

Scenario	3		4		5	
	DBB Pressurise	PULSE-80	DBB (Pa) Pressurise	PULSE-80	PULSE-80	DBB Press'
1	6.24	5.78	8.31	7.43	9.66	8.31

From scenario 1 to scenario 5, the chamber envelope leakage level increases due to a number of openings being unsealed. In scenario 6, the chamber preparation was returned to scenario 1 but with the boiler vent unsealed (note the order in Table 3). Figure 9 illustrates the changing trend of chamber leakage level measured by the DBB and PULSE-80. It shows the results given by both methods follow the same trend. However, the result given by DBB is consistently higher than PULSE-80 by 7.9%-16.2%; whereas in the sheltered environment with regular openings (Zheng 2017) the relative percentage difference ranged from -9.84% to 8.22%, giving an overall smaller deviation from the mean than this NC test. This could have been caused by the combination of extrapolation and DBB installation.

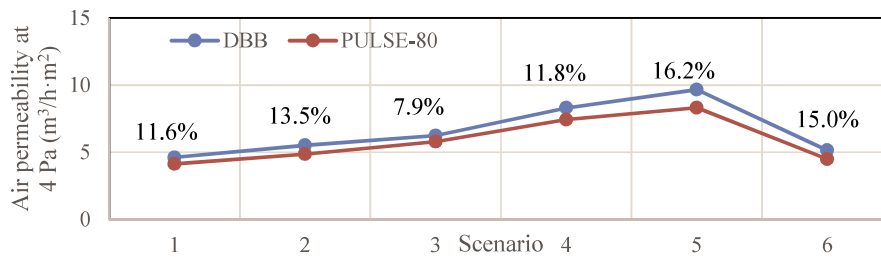

Figure 9 Trend of P4 in the six scenarios given by DBB in pressurisation mode and PULSE-80

To further investigate this difference between blower door and PULSE-80 further tests were added to scenario 6. A pressurisation test using an alternative blower door was trialled; this being the larger Blower Door-model 2 (BD-2) from Energy Conservatory. The results can be seen in the first 3 columns of Table 4 and this showed a difference of 35.9% to PULSE-80 and 18.2% to DBB for this case study. The installation of the blower door frame could contribute to this difference as the unsealed gap around the edge of the blower door is potentially quite large in relation to the relatively small volume of the enclosure. To investigate the impact of this, PULSE-80 tests were performed, whilst the separate blower doors were in-situ with fan openings sealed, i.e. to obtain the effect of the door frame in isolation. The P4 results in the final two columns in Table 4 given by the PULSE-80 suggest the envelope leakage increased by 10.3% and 14.1% for the DBB and BD-2 installations respectively, when compared to the standard PULSE 80 test (where the external doors are fully closed).

However, there is also 18.2% difference between the P4 measured in the pressurisation tests between BD-2 and DBB. The P4 measured in the pulse test when the BD-2 was installed is larger than that when DBB was installed by only 3.4%, which indicates the difference in the envelope leakage made by installations of DBB and BD-2 is small. i.e. envelope and installation leakage condition for DBB and BD-2 is very close. Hence, it is more likely the difference in P4 given by DBB and BD-2 is mainly caused by extrapolation error and model difference.

Table 4 P4 (m³/h·m²) of the chamber measured by DBB and PULSE-80 in scenario 6

Test	PULSE-80	DBB Pressurise	BD-2 Pressurise	PULSE-80 (DBB installed)	Pulse80 (with BD-2 installed)
1	4.46	4.71	6.51	4.74	5.05
2	4.44	5.20	5.55	4.75	5.05
3	4.53	5.55	6.20	5.34	5.22
Mean	4.48(±1.2%)	5.15(±8.6%)	6.09(±8.8%)	4.94(±8.0%)	5.11(±2.2%)

3. STEADY WIND TESTS (SW)

3.1. SW Test arrangement

In the steady wind (SW) tests, the enclosure was subject to an imposed external wind delivered by the portable fan as shown in Figure 13. Leakage levels were achieved by sealing up various

openings, to provide 3 testing scenarios as shown in Table 5, thus providing a wide spectrum of leakage characteristics. Scenario 3 was further split into two separate tests, by changing the position of the portable fan, thereby changing slightly the externally imposed wind direction (see Fig.13)

The setup of the DBB and PULSE-60 unit is shown in Figure 10 and Figure 11. Figure 11 shows two pulse units, including a test unit and a development unit, however, the results presented in this paper are based solely on the tests performed with the test unit. The DBB tests were conducted by a qualified BSRIA compliance engineer and the testing procedure followed the ATTMA TSL1. The pulse tests were conducted under the same experimental conditions as the DBB tests.

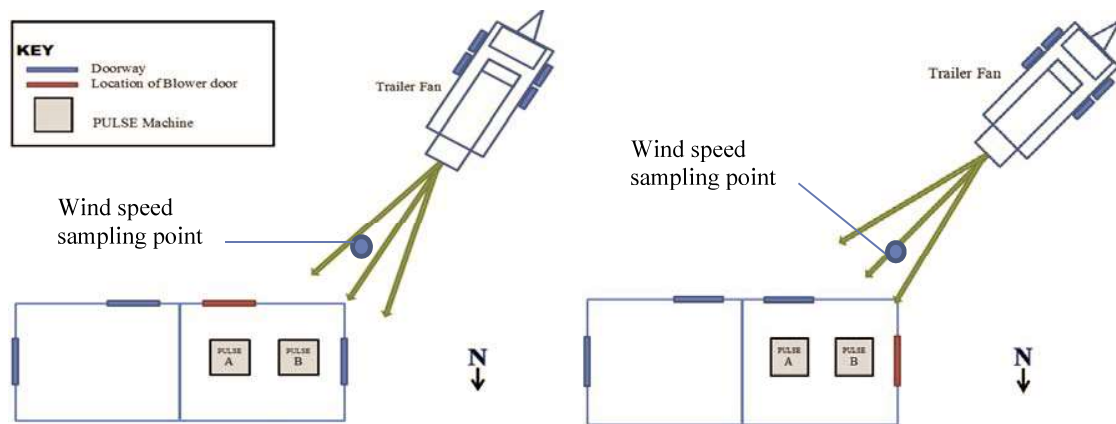

Figure 10 Setup of blower door (SW test)



Figure 11 Setup of PULSE unit (SW test)

An anemometer was used to measure wind speed in the centre of the wind flow and 1 meter away from the corner of the chamber, as shown in Figure 12. It was held approximately 1.5 meters above the ground. The duration of measurement was between 30 and 60 seconds. Due to the fluctuations of wind speed, each level is represented by a range of wind speed with a peak value. For example, ‘2.5-3.5, up to 4’ means the measured wind speed typically varies between 2.5 m/s and 3.5 m/s, and the recorded maximum wind speed is 4 m/s. Table 5 lists three different testing scenarios achieved by sealing up various openings and using two different wind directions.



Wind direction 1 (used in scenario 1,2 and 3)

Wind direction 2 (Only used in scenario 3)

Figure 12 Setup of portable fan

Table 5 Testing scenarios for SW tests

Scenario	1	2	3a	3b
Weather	8mph	7.5 mph meteorological wind	5 mph meteorological wind speed	

condition	meteorological wind speed with sunny spells	speed with sunny spells	with sunny spells.	
SW test	S-1	S-1, S-2, S-3, R3-1	S-1, S-3, R3-1, F1-3, F2	
Vent conditions	Shower extract vent was sealed	Shower extract, tumble drier vent, cooker hood vent, and static vent were sealed	shower extract, radiator vent, cat flap, cooker hood vent, and static vent were sealed	
Wind direction	1	1	1	2
Baseline	Fan off	Fan off	Fan off	Fan off
Wind 1 (m/s)	2.5-3.5, up to 4	2.5-3.5, up to 4	2.5-3.5, up to 4	2.5-3.5, up to 4
Wind 2 (m/s)	4-5, up to 7	4-5, up to 7	n/a	n/a
Wind 3 (m/s)	6.5-7.5, up to 8.7	6.5-7.5, up to 8.7	n/a	n/a
Wind 4 (m/s)	n/a	8.5-9.5, up to 11.7	n/a	n/a

3.2. SW Test results

Table 6 provides the results for the tests performed under three different chamber scenarios with no externally applied wind (i.e. portable fan off). Note that the DBB test was only performed for the fan off condition as no valid blower door test results could be obtained for conditions where the externally imposed wind is directly against the blower door fan.

Table 6. P4 (m³/h·m²) measured by DBB and PULSE-60 for fan off condition

Equipment	DBB	PULSE-60	Mean % difference between DBB and PULSE 60
	P4(m ³ /h·m ²)	P4(m ³ /h·m ²)	
Scenario 1:	9.87	9.89	-1.69%
	10.07	10.03	
	9.75	10.28	
Mean	9.90(±1.75%)	10.07(±2.10%)	
Scenario 2:	8.18	7.68	-1.62%
	7.70	8.09	
	7.85	8.34	
Mean	7.91 (±3.45%)	8.04 (±4.41%)	
Scenario 3:	9.00	9.53	-10.84%
	8.95	9.48	
	7.98	10.05	
Mean	8.64 (±7.68%)	9.69(±3.79%)	

In scenario 1 and 2, the P4 measured by DBB is smaller than that measured by PULSE-60 by 1.69% and 1.62%, respectively; while in scenario 3, the discrepancy increases up to 10.84%. Hence, like previous results in the NC tests, the range of deviation in the P4 given by both testing methods is also slightly larger than that obtained in the previous sheltered environment study. But noticeably the DBB, unlike in the NC tests, shows lower P4 values than PULSE-60 consistently in this case study. This could be caused by differences in blower door installation, weather condition, pulse model and extrapolation in the NC and SW tests. Further investigation and discussion on this will be the work of a future publication.

The measurement of P4 under various wind conditions in three different scenarios is summarised in Table 7. Baseline is the testing scenario where the fan is off. Various wind speeds were achieved, as detailed in Table 5. In both scenario 1 and 2, a good test repeatability, within ±2.7% and ±2.1%, respectively, was achieved at wind speed level 1. The tests at wind speed level 1 under both scenario 1 and 2 also showed good agreement with that done at ‘baseline’ condition, differing by -1.9% and 2.14% respectively. It suggests the wind speed level 1 doesn’t have significant impact on the pulse test in the setup given by scenario 1 and 2.

Table 7 Impact of various wind conditions on the measurement of P4 (m³/h·m²) in three different scenarios

Scenario 1					
Test	Baseline	Wind 1	Wind 2	Wind 3	
1	9.89	9.86	8.42	8.13	
2	10.03	9.93	9.54	7.30	
3	10.28	9.50	7.02	8.21	
4	9.61	n/a	n/a	n/a	
Mean	9.95(±3.4%)	9.76(±2.7%)	8.33(±15.7%)	7.88(±7.3%)	
Scenario 2					
Test	Baseline	Wind 1	Wind 2	Wind 3	Wind 4
1	7.68	8.08	7.67	5.06	7.00
2	8.09	8.42	7.98	7.67	7.92
3	8.34	8.12	8.00	7.07	5.82
4	n/a	n/a	7.62	4.64	n/a
Mean	8.04(±4.4%)	8.21(±2.1%)	7.82(±2.5%)	6.11(±25.6%)	6.91(±15.8%)
Scenario 3 (Baseline and Wind 1 only)					
Test	Baseline	Direction 1	Direction 2		
1	9.59	8.94	8.54		
2	9.36	9.82	10.08		
3	10.10	7.39	7.27		
4	n/a	n/a	n/a		
Mean	9.69(±4.3%)	8.72(±15.2%)	8.63(±16.8)		

It can be observed that P4 decreased across all scenarios with increased wind speed and also results became less repeatable, with ranges from the mean value of an individual test of $\pm 7.3\%$ (scenario 1, wind 3) to $\pm 25.6\%$ (scenario 2, wind 3). The decrease in P4 against baseline values is in the range of 2.7% - 24.0%.

In scenario 3, the impact of the wind direction to the test accuracy and repeatability was investigated at wind level 1. Three repeated tests were performed in two different wind directions; one pointing towards the chamber corner and secondly, towards the front side of the chamber. The tests done in both wind directions were less repeatable than baseline with a variation from the mean of $\pm 15.2\%$ and $\pm 16.8\%$. These deviations are much higher than that seen in the first two scenario's, which may suggest the leakage distribution might affect the wind impact on the pulse test. It can also be seen in scenario 3 that the mean results of wind directions 1 and 2 both report smaller values than the baseline test; providing a relative difference of 10.0% and 10.9% respectively. Hence it appears, with the relative closeness of the two mean results that the impact of wind direction on the test repeatability and accuracy in the case study is seemingly insignificant. By comparison increasing wind level in other scenarios to 2, 3 and 4 (i.e. 4.5m/s-9.0m/s), shows a greater impact on the repeatability and accuracy of the tests. However, these findings need further investigation due to lack of sufficient measurements.

4. DISCUSSION

In order to determine if the uncertain nature of environmental factors presented in the natural condition contributes to the difficulty of measuring low pressures accurately, it is better to use a test chamber of similar size in both sheltered and unsheltered environments. In this way any differences due to different volumes and envelope area can be eliminated. However, due to availability of an unsheltered test facility (and consideration of the practicality of introducing steady wind manually in the SW tests), a chamber of half the size of a standard 20 feet shipping container was used. This chamber is much smaller than the house-sized chamber used in the sheltered environment (Zheng 2017), and therefore, the NC test in this small chamber should be regarded as a pilot study for outdoor comparison and the conclusion drawn in the NC tests shouldn't necessarily be applied to normal houses. Further experimental investigation needs to be performed to determine if the conclusions drawn in this study stand for real houses.

In the steady wind tests, it was observed due to the function of the fan equipment (as detailed in section 1.2) that the measured wind speed is not fixed at a particular speed but fluctuates in a range due to the nature of blade movement. Hence, a stable steady wind could not be obtained in this case study, and it is represented by a range of wind speeds. Due to the limited space between the chamber and the adjacent objects such as parked vehicles and a building, the portable fan could only be set up in front of the chamber. Hence, only two different wind directions were implemented for testing. Further tests including wind flow from each side of the envelope with different opening distributions should be performed to investigate the impact of the wind direction and distribution of openings on the test results systematically.

5. CONCLUSION

The first investigation in this study looked at how pulse and the blower door methods compared in six different scenarios of envelope air tightness in the natural outdoor condition (NC). It has been found that for NC tests the P4 ($\text{m}^3/\text{h}\cdot\text{m}^2$) given by both, the blower door and the pulse methods followed a close similar trend, with the DBB blower door measurement being higher than the pulse measurement by 7.9%-16.2%, which is a slightly larger discrepancy than (Zheng 2017).

In the second experiment the repeatability of pulse under various artificially imposed steady wind (SW) speeds and direction was investigated. In scenario 1 and 2, the envelope arrangement was made different by the sealing of different openings and with no wind applied (same wind direction), good agreement of P4 given by both techniques was observed (<2%). However, in scenario 3, which involved another vent sealing arrangement and a second additional wind direction, the deviation between results increased up to 10.84%, giving a similar overall deviation range with that obtained in the NC tests. Hence, it is considered that the impact of the outdoor environmental condition is a likely contributor to the increase in deviation between the two methods in measuring P4. At wind level 1 (wind speed up to 3.5 m/s) for scenarios 1 and 2, a good repeatability ($\leq\pm 3\%$) was obtained and the P4 reported by PULSE-60 differed from that the fan-off tests by < 2.2%. However, this close agreement did not follow in scenario 3, where for wind direction 1 and 2, the P4 decreased from baseline by 10% and 10.9% respectively, suggesting the opening distribution might change the way wind impacts the pulse measurement. When the wind speed was increased to between 4.5 m/s and 9 m/s, (wind levels 2, 3 and 4) the pulse test became less repeatable, with uncertainty from the mean value increasing by up to $\pm 25.6\%$ and the P4 decreasing by 2.7%-24%. This steady wind study provides insight of how wind affects the pulse measurement based on a small outdoor chamber. These tests represent the observations seen on a limited number of tests for this case study and further experimental investigations are now required in the field of actual dwellings to determine the validity of the findings in this study.

6. REFERENCES

- Cooper EW, Etheridge DW (2007). Determining the adventitious leakage of buildings at low pressure. Part 1: uncertainties. *Building Serv. Eng. Res. Technol.* 2007; 28: 71-80.
- Cooper EW, Etheridge DW. (2007). Determining the adventitious leakage of buildings at low pressure. Part 2: pulse technique. *Building Serv. Eng. Res. Technol.* 28: 81-96.
- Cooper E., Zheng X.F., Gillot M., Riffat S., Zu Y.Q.(2014). A nozzle pulse pressurisation technique for measurement of building leakage at low pressure. *35th AIVC Conference "Ventilation and airtightness in transforming the building stock to high performance"*, Poznan, Poland, 24-25 September 2014.

- Cooper E., Zheng X.F., Wood C., Gillott M., Tetlow D., Riffat. S, Simon L. (2016) . Field trialling of a new airtightness tester in a range of UK homes. *International Journal of Ventilation*. <http://dx.doi.org/10.1080/14733315.2016.1252155>
- Sherman M.H. and Dickerhoff D., 1994 “Air-Tightness of U.S. Dwellings” In Proceedings, 15th AIVC Conference: The Role of Ventilation, Vol. 1, Coventry, Great Britain: *Air Infiltration and Ventilation Centre*, pp. 225-234. (LBNL-35700).
- Sherman M.H. and Matson N.E., 2002. “Air Tightness of New U.S. Houses: A Preliminary Report”, Lawrence Berkeley National Laboratory, LBNL 48671. Lawrence Berkeley National Laboratory, Berkeley, CA.
- Sherman M.H. and Chan R., 2004. “Building Airtightness: Research and Practice”, Lawrence Berkeley National Laboratory Report No.LBNL-53356.
- Sherman M. H., 2009 Infiltration in ASHRAE’s residential ventilation standards, Lawrence Berkeley National Laboratory, LBNL-1220E. Lawrence Berkeley National Laboratory, Berkeley, CA.
- Remi C.F., Leprince V, 2016. Uncertainties in building pressurisation tests due to steady wind. *Energy and Buildings*. Vol.116, 15th March 2016, pp 656-665.
- Orme M., Liddament M. and Wilson A., 1994 "An Analysis and Data Summary of the AIVC's Numerical Database”, Technical Note 44, Air Infiltration and Ventilation Centre, Coventry, 1994.
- Zero Carbon Hub (2014). Closing the gap between design and as-built performance: End of term report, July 2014. Available from: http://www.zerocarbonhub.org/sites/default/files/resources/reports/Design_vs_As_Built_Performance_Gap_End_of_Term_Report_0.pdf
- Zheng X.F., Cooper E., Mazzon J., Wallis I., and Christopher J.W., 2017. A comparison study of the blower door and novel pulse technique on measuring enclosure airtightness in a controlled environment *In: 38th AIVC conference, Nottingham, United Kingdom, 13-14 September 2017.*