

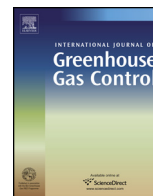

Contents lists available at ScienceDirect

International Journal of Greenhouse Gas Control

journal homepage: www.elsevier.com/locate/ijggc



Process simulations of post-combustion CO₂ capture for coal and natural gas-fired power plants using a polyethyleneimine/silica adsorbent

Wenbin Zhang^a, Chenggong Sun^a, Colin E. Snape^a, Robin Irons^b, Simon Stebbing^c,
Tony Alderson^d, David Fitzgerald^e, Hao Liu^{a,*}

^a Faculty of Engineering, University of Nottingham, University Park, Nottingham NG7 2RD, UK

^b Uniper Technologies Limited, Technology Centre, Ratcliffe on Soar, Nottingham, NG11 0EE, UK

^c PQ Silicas UK Limited, Bank Quay, 4 Liverpool Road, Warrington, Cheshire, WA5 1AB, UK

^d WSP | Parsons Brinckerhoff, Units 4 & 5 Ferrybridge Business Park, Ferrybridge, WF11 8NA, UK

^e Doosan Babcock Limited, Porterfield Road, Renfrew, PA4 8DJ, UK

ARTICLE INFO

Article history:

Received 12 September 2016

Received in revised form 1 December 2016

Accepted 2 December 2016

Available online xxx

Keywords:

Post-combustion carbon capture

Solid adsorbent

Process simulation

PEI/silica

Plant efficiency

ABSTRACT

The regeneration heat for a polyethyleneimine (PEI)/silica adsorbent based carbon capture system is first assessed in order to evaluate its effect on the efficiency penalty of a coal or natural gas power plant. Process simulations are then carried out on the net plant efficiencies for a specific supercritical 550 MWe pulverized coal (PC) and a 555 MWe natural gas combined cycle (NGCC) power plant integrated with a conceptually designed capture system using fluidized beds and PEI/silica adsorbent. A benchmark system applying an advanced MEA absorption technology in a NETL report (2010) is used as a reference system. Using the conservatively estimated parameters, the net plant efficiency of the PC and NGCC power plant with the proposed capture system is found to be 1.5% and 0.6% point higher than the reference PC and NGCC systems, respectively. Sensitivity analysis has revealed that the moisture adsorption, working capacity and heat recovery strategies are the most influential parameters to the power plant efficiency. Under an optimal scenario with improvements in increasing the working capacity by 2% points and decreasing moisture adsorption by 1% point, the plant efficiencies with the proposed capture system are 2.7% (PC) and 1.9% (NGCC) points higher than the reference systems.

© 2016 The Authors. Published by Elsevier Ltd. This is an open access article under the CC BY license (<http://creativecommons.org/licenses/by/4.0/>).

1. Introduction

CO₂ capture and storage (CCS) from large point anthropogenic CO₂ emission sources, such as coal and natural gas fired power plants, has been well recognized to be one of the most effective and near-term measures to mitigate the increasing atmospheric CO₂ level. Deployment of the CCS technologies can potentially bring approximately 20% reduction in the overall global greenhouse gas emissions by 2040 in IEA's 450 Scenario (IEA, 2015; EBTP, 2012). Post-combustion capture is one of the front runners of CO₂ capture technologies for future commercial applications in fossil fuel power plants, partly due to the fact that it can be easily retrofitted to the existing power plants.

The overall energy required to operate a CCS system is the sum of the thermal energy needed to regenerate the solvents/sorbents and the electrical energy needed to operate pumps, gas blowers or fans. Energy is also required to compress the recovered CO₂ to the final pressure for transportation and storage. These extra energy requirements, together with the capital investments of the equipment will induce a significant increase in the cost of electricity (COE), by 70–100% with existing CCS technologies such as aqueous monoethanolamine (MEA) scrubbing (Haszeldine, 2009; NETL, 2010; Mondal et al., 2012; EPA, 2016). A recent analysis on retrofitting CCS to existing coal-fired power plants has shown that CCS implementation was not economically favourable for those plants with efficiencies less than 35% (low heating value (LHV) based, mainly subcritical) (IEA, 2011, 2015). Although natural gas plays an important role in the power generation sector, the CO₂ capture cost of a natural gas fired power plant is higher than that of a coal fired power plant (Middleton and Eccles, 2013). The overall costs associated with a CCS system with post-combustion CO₂

* Corresponding author.

E-mail address: liu.hao@nottingham.ac.uk (H. Liu).

<http://dx.doi.org/10.1016/j.ijggc.2016.12.003>

1750-5836/© 2016 The Authors. Published by Elsevier Ltd. This is an open access article under the CC BY license (<http://creativecommons.org/licenses/by/4.0/>).

capture mainly include capital cost, operating cost, sorbent replacement and employee cost, where capital and operating costs are two major contributors. Recently, the techno-economic performance of the MEA-based CO₂ capture process has been evaluated by several researchers using different methodologies (Abu-Zahra et al., 2007; Rubin et al., 2013; Raksajati et al., 2013; Zhao et al., 2013a; Manzoloni et al., 2015; Li et al., 2016). Abu-Zahra et al. (2007) estimated that the capital expenditure was around 28% while the operational cost relevant to regeneration heat was around 44%, excluding compression cost. As an example in a techno-economic analysis (Li et al., 2016), the specific capital investment of the post-combustion capture (PCC) plant using the MEA-based process with a 650 MWe PC power plant was estimated to be 2013 USD 1357/kWe, while the CO₂ avoided cost for this process was 2013 USD 86.4/tCO₂. By combining several process improvements, the optimized process has the potential to reduce the capital cost to 2013 USD 1285/kW and the CO₂ avoided cost to 2013 USD 75.1/tCO₂ (Li et al., 2016).

Over the past years, the chemical absorption has been substantially improved with the development of novel solvents and advanced process designs such as flow sheet modifications (Cousins et al., 2011; IEA 2011, 2015; Han et al., 2011; Mondal et al., 2012). “Efficiency penalty” is generally regarded as an index for evaluating the difference in power plant efficiency between the plant without CCS and that integrated with CCS. The efficiency penalty of a coal or natural gas-fired power plant with chemical absorption technology has been investigated by numerous researchers using commercially available software packages such as Spence[®] and Aspen[®] (Strube and Manfrida, 2011; Dave et al., 2011; Khalilpour and Abbas, 2011; Berstad et al., 2011; Sanpasertparnich et al., 2010; Stover et al., 2011; Ystad et al., 2012; Liebenthal et al., 2011; Amrollahi et al., 2012; Li et al., 2016).

Solid adsorbents have been comprehensively investigated for post-combustion CO₂ capture owing to their potentials in fast adsorption and desorption kinetics, high adsorption capacity, reliable regenerability and stability and tuneable range of operating conditions. Reviews on the recent development of solid adsorbents for post-combustion CO₂ capture can be found in Samanta et al. (2012), Hedin et al. (2013), Wang et al. (2011, 2014) and Abanades et al. (2015). Among all solid adsorbents, amine-based adsorbents are regarded as the most advanced and cost-effective materials (Belmabkhout and Sayari, 2009; Drage et al., 2008; Choi et al., 2009; Son et al., 2008; Gray et al., 2009; Ebner et al., 2011; Dutcher et al., 2015). Despite of numerous investigations on material development, however, only a few studies have focused on the process assessment for solid adsorbent based CCS systems to be integrated into coal or natural gas fired power plants (Chaffee et al., 2007; Veneman et al., 2013; Glier and Rubin, 2013; Kim et al., 2014a; Kim et al., 2014b), while most of them were conducted using theoretical models.

Process simulation of a coal or natural gas fired power plant integrated with a CCS system requires comprehensive knowledge of many parameters associated with the fuel properties, physical and adsorption data of the selected adsorbent, flue gas composition and conditions, as well as the specific process design details of adsorbents and regenerators. The authors of this paper had demonstrated the performance of a polyethyleneimine (PEI)/silica adsorbent in a fluidized bed reactor and also proposed a conceptual design of fluidized bed adsorber/desorber for air capture purpose (Zhang et al., 2014a,b). In the present study, the previously obtained data have been incorporated into the process simulations for a coal and a natural gas fired power plant integrated with CCS systems using the PEI/silica adsorbent. Fluidized bed adsorbents and desorbents are designed conceptually according to the specific flue gas conditions. Efficiency penalties have been evaluated and compared with the reference benchmark CCS system using an advanced MEA absorp-

Table 1
Characteristics and regeneration heat of PEI/silica adsorbent.

Real density (kg/m ³)	1400
Bulk density (kg/m ³)	700
Diameter (μm)	250
Specific heat $C_{p,s}$ (kJ/kgK)	1.81
Heat of adsorption ΔH_a (kJ/kgCO ₂)	2160 (PC), 2000 (NGCC)
Temperature difference ΔT (K)	60
Working capacity q_w (wt%)	6 (PC), 5 (NGCC)
Moisture adsorption f_{H_2O} (wt%)	2
Recovery ratio α	0.75
Recovery ratio β	0.25
Recovery ratio γ	0.5
Regeneration heat Q_r (GJ/tCO ₂)	2.45 (PC), 2.50 (NGCC)

tion technology (NETL, 2010) and another solid sorbent based CCS system (Veneman et al., 2013). It is worth noting that most of the parameters adopted in the process simulation of this study are based on the experimental results obtained with a bubbling fluidized bed CO₂ adsorber/desorber, thermal gravimetric analyzer (TGA) and differential scanning calorimetry (DSC) (Zhang et al., 2014a,b, 2016) and therefore the uncertainties with the process simulation parameters for the specific PEI/silica adsorbent used in this study are minimized.

2. Thermal energy requirement for regeneration

The regeneration heat is usually regarded as the most important criteria to evaluate different materials and processes and to assess their respective performance for applications in commercial-scale CO₂ capture systems. Reducing the required regeneration heat is the most effective measure to minimize the loss in net plant efficiency. According to Goto et al. (2013), an approximate 2% efficiency improvement can be expected by reducing the regeneration energy of the capture system by 1 GJ/tCO₂.

In principle, the regeneration heat comprises firstly the sensible heat which is necessary to increase the solvent/sorbent from the adsorption temperature to the regeneration temperature in a typical temperature swing adsorption (TSA) process; secondly the heat of adsorption which is needed to overcome the chemical bonding strength between the adsorbed CO₂ and the adsorbent; and thirdly the latent heat which is required to evaporate the water content in the solvent or sorbent. The calculation of regeneration heat can then be expressed as (Zhang et al., 2016):

$$Q_r = \frac{1 - \alpha}{q_w} C_{p,s} (T_{de} - T_{ad}) + (1 - \beta) \Delta H_a + (1 - \gamma) \frac{Q_v f_{H_2O}}{q_w} \quad (1)$$

where Q_r (GJ/tCO₂) is the regeneration heat requirement, q_w (wt%) is the working capacity of the solvent/sorbent under given working conditions; α , β , γ are the fractions of heat recovered from sensible heat, heat of adsorption and vaporization heat, respectively, which can be realized through proper process designs; $C_{p,s}$ (kJ/kgK) is the specific heat capacity of the solvent/sorbent; T_{ad} and T_{de} (K) are the temperatures of adsorption and desorption processes respectively; ΔH_a (kJ/kgCO₂) is the absolute value of heat of adsorption; Q_v (kJ/kg) is the vaporization heat of water which equals to 2257.6 kJ/kg under ambient pressure; and f_{H_2O} (wt%) is the mass fraction of water content that is evaporated in the regenerator.

The solid adsorbent used in this study was synthesised by impregnating a mass ratio of 40% PEI into an inorganic mesoporous silica support (Drage et al., 2008). The PEI has a molecular weight (MW) of 1800 in hyperbranched forms supplied by Sigma–Aldrich, UK. Characterization of the PEI/silica adsorbent by TGA, NMR, DRIFT, XPS and fluidized bed can be found in previous publications (Drage et al., 2008; Zhang et al., 2014a,b). Detailed parametric analysis on all the parameters in Eq. (1) can be found in Zhang et al. (2016) and the main results are summarized in Table 1.

The DSC testing results have shown that the value of heat of adsorption is dependent on the CO₂ partial pressure in the flue gas (Zhang et al., 2016). The heat of adsorption for the PC case (15% CO₂) is 2160 kJ/kgCO₂ which is slightly higher than the NGCC case (5% CO₂) of 2000 kJ/kgCO₂. The process dependant working capacity is different from the equilibrium capacity which can be determined by TGA, fixed bed or batch-type fluidized bed tests under isothermal conditions. In a practical regeneration process, pure CO₂ or pure steam or a mixture of CO₂ and steam will have to be used as the sweep gas in order to get high purity product gas of CO₂. However this may cause an incomplete desorption comparing with most TGA, fixed bed and batch-type fluidized bed tests using pure N₂ as the sweep gas. Secondly, the solid residence time in practical adsorber and desorber reactors is much shorter than the time taken to reach the equilibrium condition. Therefore breakthrough capacity should be used as the working capacity. Finally, the circulating solid adsorbent particles are most likely partially degraded after many cycles even with a constant replacement rate. Based on the above considerations, the working capacities in this study are adopted as 6 wt% for the PC case and 5 wt% for the NGCC case, which are both substantially lower than the equilibrium capacities demonstrated on previous TGA and cyclic batch-type fluidized bed tests (Zhang et al., 2014b). The moisture adsorption of 2wt% was experimentally determined for the PEI/silica adsorbent in a modified TGA system which can generate a certain level of moisture with the carrier gas. The adsorption capacity of the moisture was obtained in the pre-saturation test of moisture followed by the co-adsorption of both CO₂ and moisture at the adsorption temperature of 70 °C. Details of the experimental procedures and results can be found in Zhang et al. (2016).

By substituting the parameters listed in Table 1 into Eq. (1), one can calculate the regeneration heats to be 2.45 GJ/tCO₂ for the PC case and 2.50 GJ/tCO₂ for the NGCC case. For comparison, the regeneration heat for a typical aqueous 30% MEA CO₂ capture system is around 3.90 GJ/tCO₂ (Chapel et al., 1999; Alie et al., 2005; Singh et al., 2003; Sjoström and Krutka, 2010), whereas for the advanced MEA system with the optimized process configurations, the regeneration heat is about 3.30 GJ/tCO₂ (IEA, 2011; Abu-Zahra et al., 2007; Veneman et al., 2013). It should be noted that the regeneration heat calculated by Eq. (1) is purely on the basis of thermodynamic energy balance using the nominated parameters in Table 1 without considering any specific process and devices. Due to the lack of literature data, the largest uncertainties come from the adopted heat recovery ratios. For simplicity, these ratios were represented as the effective reductions in the required regeneration heat (Zhang et al., 2016).

3. Conceptual design of CO₂ capture systems for PC and NGCC power plants

3.1. Process description

One of the main advantages of post-combustion carbon capture is that the capture plant is dealing with the flue gas so that the CCS system can be retrofitted to existing power plants without significant modifications to the current configurations. The capture plant can be located at the end of process chain, normally between the flue gas treatment devices and the stack. We assume here that the concentrations of contaminants (e.g. NO_x, SO₂) after the existing flue gas treatment facilities such as selective catalytic reduction (SCR), particle matter remover and flue gas desulfurization (FGD) can also meet the requirements of the adsorbent and process in a carbon capture plant so that no additional flue gas polishing measures are needed.

Fig. 1 illustrates the block flow diagram (BFD) of the conceptual flow sheet of a typical 550 MWe supercritical PC fired power plant integrated with a solid adsorbent based CCS system (adapted from NETL, 2010). After the flue gas passes FGD where SO₂ removal is carried out, it is directed into the CCS system instead of entering the stack directly as for the case of a power plant without CO₂ capture. Each unit of the CCS system consists of an adsorber where CO₂ in the flue gas is adsorbed by the solid adsorbent together with a desorber where the adsorbent is regenerated under controlled conditions. The cyclone is used to capture the entrained adsorbent from the adsorber while the CO₂ free flue gas exits from the top of the cyclone and is released to the atmosphere through the stack. The high purity CO₂ product gas from the exit of the desorber is compressed and sent to storage.

The regeneration heat required can be provided by steam condensation via an in-bed heat exchanger (HX). One option for the steam supply is to integrate the original plant steam and feed water cycle with the capture plant by extracting the superheated steam from the low pressure (LP) crossover pipe. After heat exchange in the desorber, the steam is condensed as feed water and then returned to the main feed water system. Due to the extraction of steam from the LP turbine, the actual gross power output has been reduced, leading to lower plant efficiency. Using a dedicated boiler to provide steam to the capture plant is another option which requires minimal changes to the original power plant. In this case, the flue gas generated by the dedicated boiler containing CO₂ will have to be re-directed to the capture plant if a high overall CO₂ capture ratio (e.g. 90%) is to be maintained. The overall plant efficiency with this option is however lower than that of the plant with steam extraction as the extra thermal energy input to the dedicated boiler does not generate any power (Popa et al., 2011; Bashadi, 2010). Therefore, the option with steam extraction from LP turbine is adopted in this study.

The configuration of the CCS system integrated with a NGCC power plant for post-combustion capture is similar to that of a coal-fired power plant with the CCS system. Fig. 2 illustrates the block flow diagram of a typical 555 MWe NGCC power plant retrofitted with a solid adsorbent based CCS system (adapted from NETL, 2010). The flue gas exits from the heat recovery steam generator (HRSG) and enters the CCS system where CO₂ is captured and the adsorbent is regenerated. Depending on the working temperature of the selected adsorbent, additional cooling may be required for the flue gas before entering the CCS system but this is not included in the process simulation of this study.

3.2. Conceptual design of fluidized beds for CO₂ capture

Proficient solid handling and particle technologies are essential to circulate the solid adsorbent particles at a certain rate in a closed loop. The type of gas-solid contactor has considerable importance in determining the overall working performance of a specific solid adsorbent. Fluidized beds have been widely used in different industrial applications, mainly due to their high gas-solid contact efficiency and high mass/heat transfer rates. Recently, the application of fluidized bed reactors as the adsorber or regenerator for CO₂ capture with solid adsorbents has also received noticeable attention. Yang and Hoffman (2009) had proposed a moving bed as a regenerator but finally concluded that the moving bed was not promising due to poor heat transfer. ADA environmental solutions had made a survey on four main processes including entrained flow, moving bed, trickle down reactor and fluidized bed and concluded that the fluidized bed was the most reliable and cost-effective reactor option for the solid sorbent based CCS system (ADA, 2010). Continuous CO₂ capture was recently demonstrated by using silica supported sorbents impregnated with tetraethylenepentamine (TEPA) in a lab scale fluidized bed to produce a high purity (90%) of

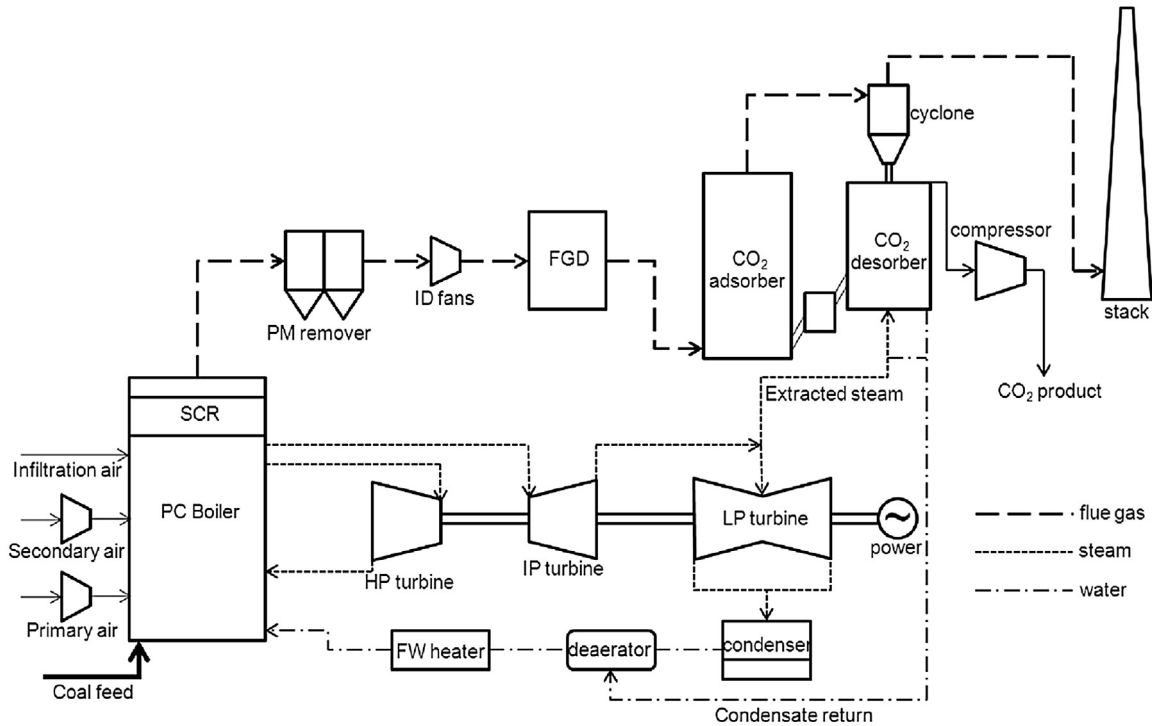

Fig. 1. Block Flow Diagram of a PC power plant with CO₂ capture.

Source: adapted from NETL (2010).

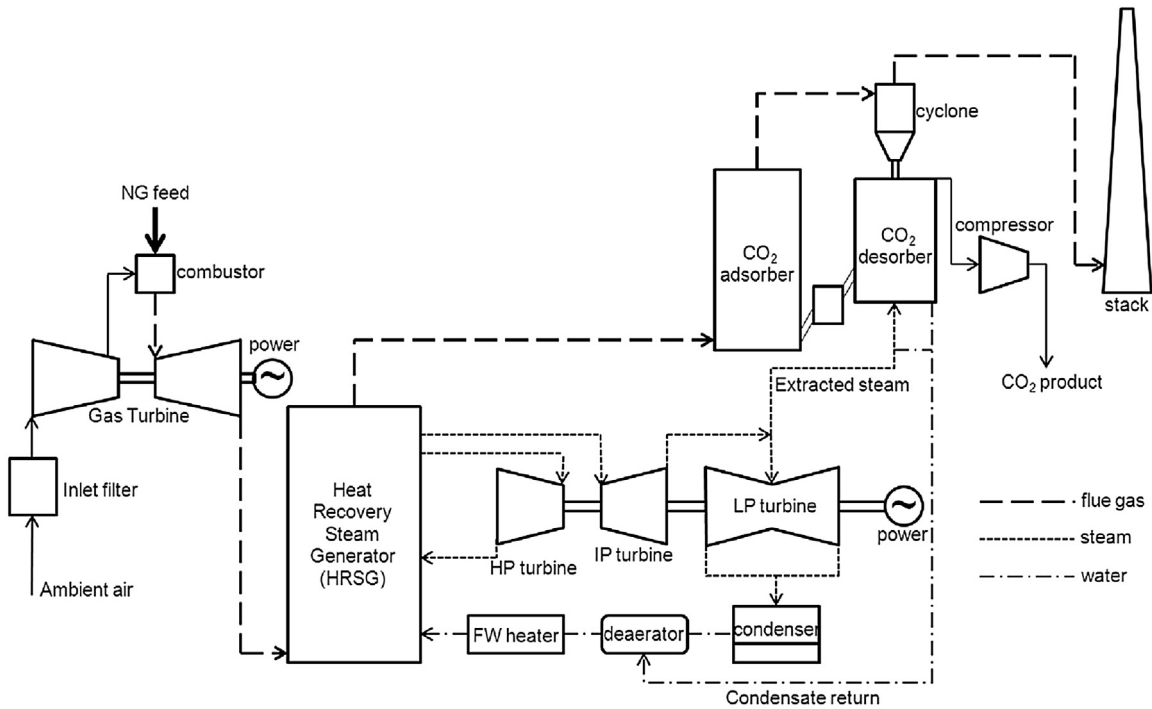

Fig. 2. Block Flow Diagram of a NGCC power plant with CO₂ capture.

Source: adapted from NETL (2010).

CO₂ product gas (Veneman et al., 2012). By use of theoretical analysis, Pirngruber et al. (2013) found that the performance of both fixed bed and fluidized bed processes improved when operated under isothermal conditions which are more difficult to achieve for a fixed bed as the heat transfer is much slower than in a fluidized bed. Kim et al. (2014b) proposed a solid sorbent-based multi-stage fluidized

bed process with inter-stage heat integration and used a flow-sheet simulation to assess the energy efficiency of the system. The feasibility of using a three-staged circulating fluidized bed as the CO₂ adsorber and a single bubbling fluidized bed as the regenerator is being demonstrated on a 1 MWe solid sorbent PCC pilot facility at a coal fired power plant in Birmingham, USA which was constructed

and commissioned in 2013 (Sjostrom et al., 2011; Starns et al., 2012; Krutka et al., 2013).

Therefore, fluidized bed technologies are adopted in the proposed conceptual design with details illustrated in Fig. 3. Each unit of the CCS system consists of a circulating fluidized bed (CFB) serving as the CO₂ adsorber coupled with a bubbling fluidized bed (BFB) serving as the adsorbent regenerator, together with other auxiliary equipment including cyclone, loop seal and heat exchangers. This integrated and compact system enables the adsorbent to be continuously circulated in a closed loop. The CO₂ in the flue gas exiting from FGD (for the PC case) or from HRSG (for the NGCC case) is fed into the CFB adsorber where the solid phase and the gas phase mix and react with each other. Some of the solid adsorbent particles are entrained with the flue gas at a constant circulating rate after a period of solid residence time in the CFB adsorber which should be sufficient to achieve the designed capture efficiency (90% in this study). As the CO₂ adsorption is an exothermic process, cooling water is required to maintain the CFB temperature to the optimal working condition. The released heat in the CFB adsorber can also be recovered by this way. The adsorbent carried over by the flue gas is captured by an efficient gas-solid separator such as a cyclone and directed into a BFB reactor where the adsorbent is regenerated at an elevated temperature according to a TSA regeneration strategy. The regenerated adsorbent is subsequently directed into the loop seal where it is cooled down to the adsorption temperature in the CFB adsorber. To improve the thermal efficiency of the whole system, the sensible heat contained in the hot adsorbent has to be recovered by heating the cooling medium (such as water) in the loop seal and circulating the medium to another heat exchanger to preheat the cold adsorbent before entering the BFB desorber. This sensible heat recovery strategy (with the ratio α) can effectively reduce the thermal energy required for regeneration in the desorber.

Despite of the recent research efforts, there are still notable uncertainties regarding the composition of sweep gas used for regeneration of amine-based solid adsorbents. Using pure CO₂ as the sweep gas can yield high purity CO₂ product gas but at the risk of serious thermal and CO₂ induced degradation and much lower working capacity (Drage et al., 2008; Serna-Guerrero et al., 2010; Veneman et al., 2012; Hoffman et al., 2014). Using pure steam can alleviate these problems (Gray et al., 2009; Li et al., 2010a) however at the cost of additional thermal energy penalty and additional water/steam treatment facilities. Long periods of exposure to the steam may also reduce the performance of amine-based adsorbents as steam is likely to extract the lower molecular weight PEI oligomers, as observed recently (Li et al., 2010b; Hammache et al., 2013; Hoffman et al., 2014). While the regeneration strategy regarding the usage of different sweep gases needs further investigation, we are proposing a mixture of 75% CO₂ and 25% steam to be used as the sweep gas in this study. The 75% CO₂ in the sweep gas is provided by recirculating a portion of the product CO₂ from the exit of BFB desorber and the 25% steam comes from the extracted steam from the LP turbine. The main portion of this extracted steam is cooled down to the saturated condition by mixing condensate water and fed into the heat exchanger in the BFB desorber to provide regeneration heat. The condensate water can then be used as preheated feed water and is returned to the main feed water system. The sweep gas, together with the steam evaporated from the moisture content in the adsorbent, can be directed into the upper heat exchanger (Upper HX in Fig. 3) under the cyclone where heat recovery (with the ratio of γ) of the latent heat of steam can be realized by condensing the steam. The high purity CO₂ product gas from the exit of the heat exchanger is separated and compressed to the required pressure for transportation. The heat of adsorption, which is released in the CFB adsorber, is much more difficult to recover due to its nature of low grade heat. With the proposed CCS system, the temperature of the cooling water at the exit of the heat

Table 2
Flue gas properties.

	PC (exit of FGD)	NGCC (exit of HRSG)
Compositions		
Carbon dioxide (Vol%)	13.8	4.1
Moisture (Vol%)	7.5	7.9
Oxygen (Vol%)	3.6	12.1
Nitrogen (Vol%)	75.1	75.9
Temperature (K)	330	379
Pressure	1.02	1.02
Flue gas mass flow rate (t/h)	2288	3154
CO ₂ mass flow rate (t/h)	467.1	201.8

exchanger in the CFB adsorber cannot exceed the adsorption temperature; therefore, it cannot be used to preheat the adsorbent. One strategy to recover the heat of adsorption (with ratio of β) is to integrate the cooling water into the feed water system thus resulting in a reduction in the overall thermal heat input of the power plant, and this is adopted in the process simulation of this study.

3.3. Determination of conceptual design data

The properties of the selected solid adsorbent have been summarised in Table 1. In order to compare with the reference carbon capture system using aqueous MEA based Fluor Econamine FG Plus technology (Reddy et al., 2008) in the NETL report (2010), the same fuel properties (Illinois No. 6 bituminous coal for the PC case and natural gas for the NGCC case) are adopted in the present process simulations with the details shown in NETL (2010). The compositions of the flue gas from the typical 550 MWe PC and 555 MWe NGCC power plants are listed in Table 2. The flue gas from the PC power plant has a much higher CO₂ concentration at 13.8% comparing with 4.1% for the NGCC case. Another notable difference is that the flue gas from the NGCC power plant has a much higher O₂ concentration (12.1%) than that of the PC flue gas (3.6%). The high O₂ level in the flue gas may cause greater oxidative degradation problems for the amine based adsorbents. However, it had been demonstrated on the bubbling fluidized bed that the degradation of the PEI/silica adsorbent could be largely prevented with 8.8% of moisture present in the simulated flue gas and in the sweep gas during desorption (Zhang et al., 2014b). The temperature of the flue gas from the PC power plants is 330 K. It is slightly lower than the optimal adsorption temperature of 343 K for the selected PEI/silica adsorbent as determined previously in TGA tests and further verified in BFB tests (Zhang et al., 2014b). As the adsorption itself is an exothermal process, preheating of the flue gas is not considered to be necessary as cooling is needed to regulate the adsorber temperature to be around the optimal value. Whereas, the temperature of the flue gas from the NGCC power plants is still as high as 379 K and therefore further cooling is needed before the flue gas enters the CO₂ capture system. The energy associated with the operation of NGCC flue gas cooling is however not included in the present process simulation. The flow rate of the flue gas of the NGCC plant is higher than that of the PC plant although the actual CO₂ flow rate is much lower than that of the PC plant. The flow rate of the flue gas determines the dimensions of the CFB adsorber at a given fluidization velocity.

The conceptual design data of the CFB adsorbers and BFB desorbers for CO₂ capture from the PC and NGCC power plants are summarized in Table 3. According to the dimensions of commercially available fluidized beds (Basu, 2006), the cross sectional areas of the designed fluidized beds are within the range of 36–110 m², resulting in a total unit number of only 2 for the given flue gas flow rate and the adopted superficial fluidization velocity. This may lead to a significant savings in the capital investment comparing to a similar scale power plant with a MEA system as there are usually 4

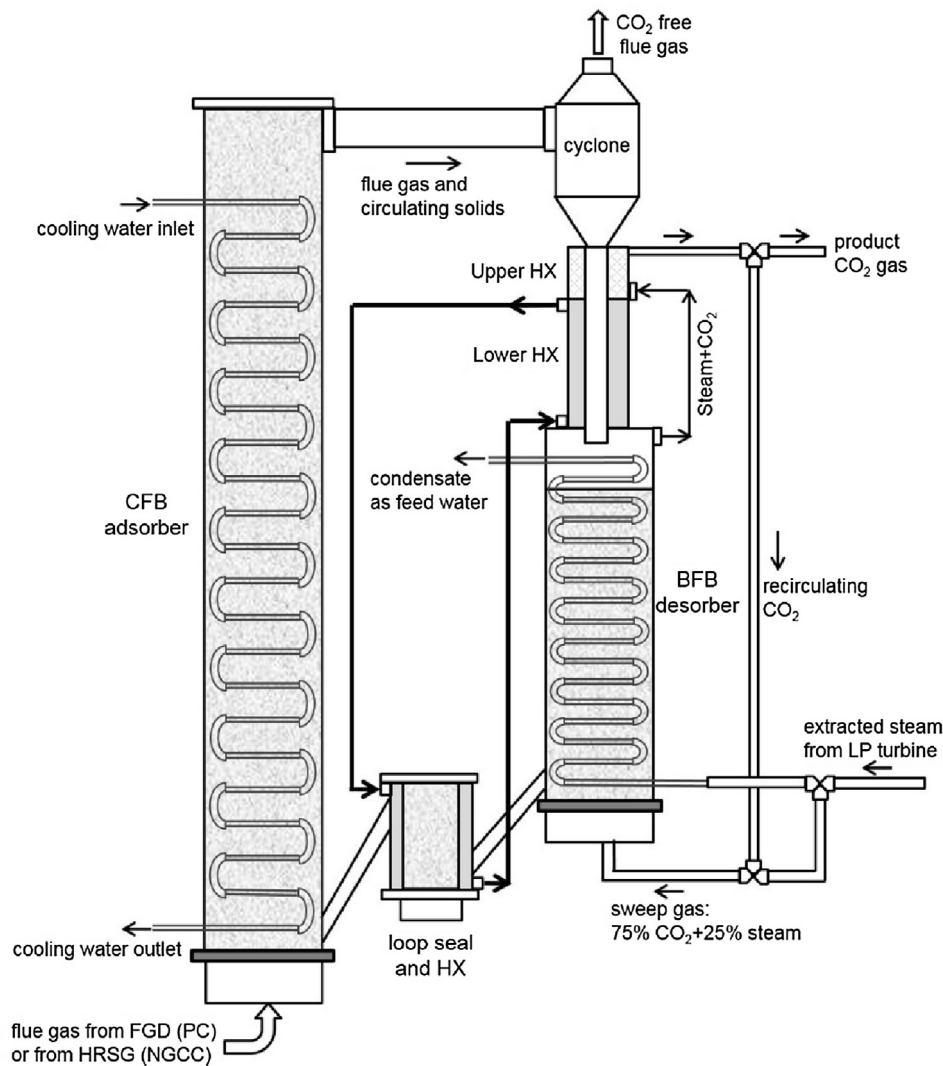

Fig. 3. Conceptual design of fluidized bed systems for CO₂ capture and adsorbent regeneration.

Table 3
Conceptual design data for each unit of adsorber and desorber in the CCS system.

	PC Adsorber	PC Desorber	NGCC Adsorber	NGCC Desorber
Number of units required	2	2	2	2
Bed temperature (K)	343	403	343	403
Minimum fluidization velocity U_{mf} (m/s)	0.027	0.028	0.026	0.028
Terminal velocity U_t (m/s)	1.105	1.087	1.106	1.087
Superficial velocity U_0 (m/s)	3.87	0.111	3.87	0.111
U_0/U_t (adsorber) or U_0/U_{mf} (desorber)	3.5	4	3.5	4
Total actual gas flow rate (m ³ /s)	278 (flue gas)	7.1 (sweep gas)	434.4 (flue gas)	4.0 (sweep gas)
Fluidization regime	fast	bubbling	fast	bubbling
Bed cross-section shape	square	square	square	square
Cross-section dimension (m × m)	8.5 × 8.5	8 × 8	10.6 × 10.6	6 × 6
Bed height (m)	50	26	50	31
Solid static bed height (m)	5.9	6.6	2.5	7.8
Inventory bed mass (t)	295	295	196	196
Required bed pressure drop (bar)	0.43	0.49	0.20	0.56
Gas-solid contact time (s)	13	60	13	70
CO ₂ capture rate (%)	90	–	90	–
CO ₂ captured/desorbed in each unit (t/day)	4724	4724	2179	2179
Solid circulating rate (kg/s)	911	911	504	504
Solid flux rate (kg/m ² s)	12.7	14.2	4.5	14.0
Mean solid residence time (min)	5.4	5.4	6.5	6.5
Heat exchanged in each unit (MW)	118.1	165.4	50.4	76.6
Regeneration heat required (GJ/tCO ₂)	–	3.03	–	3.04

units of CCS systems to meet the demand of the specific capturing capacity (NETL, 2010).

The adsorbent particles in the CFB adsorber are fluidized by the flue gas itself with additional fans pressurising the flue gas to overcome the pressure drop in the gas distributor, bed materials and the cyclone. The adsorber is operated in the regime of fast fluidization with a high superficial velocity to facilitate the mixing and reactions between the adsorbent and the flue gas. The bed height of the CFB adsorber is determined by the superficial velocity and the gas-solid contact time which is required to achieve the target of capture efficiency. The cross sectional shapes of the CFB and BFB reactors are designed as square for the ease of construction.

The capture efficiency is assumed to be 90% in the process design as also used by other researchers (Heesink et al., 2013; Veneman et al., 2013; Abu-Zahra et al., 2007; Yang and Hoffman, 2009; Pirngruber et al., 2013). It had been previously demonstrated on the bubbling fluidized bed (Zhang et al., 2014b) that the capture efficiency could be as high as 100% within a short gas-solid contact time of 13 s which is also adopted in the present conceptual design. The inventory bed mass is a product of the solid circulating rate and the mean solid residence time. The solid circulating rate gives an indication of how much used adsorbent is carried over to the desorber and at the same time how much the regenerated adsorbent are returned to the adsorber. It is determined by how much CO₂ needs to be adsorbed in the adsorber and the working capacity of the adsorbent.

The high temperature in the desorber is the main driving force to release the captured CO₂ from the adsorbent while the sweep gas promotes the desorption process to happen by fluidizing the adsorbent in the desorber. The flow rate of the sweep gas is dependent on the chosen fluidization velocity. To minimize the additional energy required to drive and heat the sweep gas, the desorbers are designed to operate in the regime of bubbling fluidization where four times of minimum fluidization velocity is used as the superficial velocity. The mean solid residence time in the desorbers is assumed to be the same with that in the adsorbers. The solid circulating rate required for a NGCC case is 504 kg/s, which is much lower than 911 kg/s for a PC case due to the lower CO₂ flow rate in the NGCC power plant flue gas.

The regeneration heats for both PC and NGCC cases listed in Table 3 in the specific design are higher than those in Table 1 as different recovery strategies for heat of adsorption and different energy supplies for regeneration are used. Fig. 4 illustrates two proposed options of heat recovery strategies for heat of adsorption and energy supplies for regeneration. Heat recovery strategy option 1 (HR1) is defined that the heat of adsorption (Q_{ad}) in the CFB adsorber is recovered (with a ratio of $\beta=0.25$) by preheating a portion of feed water so that the thermal energy input (Q_f) to the power plant is reduced to $Q_f - \beta Q_{ad}$. The regeneration heat $Q_{r,0}$ required in the BFB desorber is defined as:

$$Q_{r,0} = (1 - \alpha) Q_s + Q_{ad} + (1 - \gamma) Q_v \quad (2)$$

where Q_s is the sensible heat requirement.

$Q_{r,0}$ is supplied by the extracted steam from LP turbines in HR1. Heat recovery strategy option 2 (HR2) is defined to recover the heat of adsorption Q_{ad} (with a ratio of $\beta=0.25$) by circulating the cooling water as the heat transfer medium (HTM) from the CFB adsorber to the BFB desorber. A dedicated boiler is required to provide additional heat to further increase the temperature of HTM to the desorption temperature. Using HR2 can effectively reduce the required regeneration heat from $Q_{r,0}$ to $Q_{r,0} - \beta Q_{ad}$. However, the dedicated boiler in HR2 needs extra thermal energy input (Q_f') and produces no additional electricity work which makes the overall power generation efficiency of the power plant with CCS no better than the option HR1 where low grade steam is used as the energy supply. More detailed analysis of the overall performance of using

the dedicated boiler as the energy supply can be found in Popa et al. (2011) and Bashadi (2010) and is not within the scope of this study.

Fig. 5 illustrates the breakdown of the regeneration heat originating from the sensible heat, heat of adsorption and moisture evaporation. It is obvious that without any kind of heat recovery ($\alpha = \beta = \gamma = 0$), the total regeneration heat for either the PC case (4.79 GJ/tCO₂) or the NGCC case (5.15 GJ/tCO₂) is much higher than the basic MEA case (3.90 GJ/tCO₂) and the advanced MEA case (3.30 GJ/tCO₂) (NETL, 2010), both of which include 90% of sensible heat recovery. Using HR1 and the specific conceptual design proposed in this study, the total regeneration heat (3.03 GJ/tCO₂ for the PC case and 3.04 GJ/tCO₂ for the NGCC case) is noticeably lower than the basic MEA case and the advanced MEA case. The total regeneration heat can be further reduced to 2.49 GJ/tCO₂ for the PC case and 2.54 GJ/tCO₂ for the NGCC case if HR2 is adopted. It can also be found that the heat of adsorption makes the largest contribution to the total regeneration heat while the recovery of this portion of the low grade heat is most practically difficult.

4. Process simulations of power plants integrated with the proposed CO₂ capture system

4.1. Efficiency penalty of a power plant with CCS

The net power plant efficiency is the most important and apparent factor to assess the economic performance of a power plant with and without the CCS system. For a power plant without CCS, it can be defined as the percentage of the total thermal energy input of the feed fuel that is converted into electricity, as shown in Eq. (3):

$$\eta = \frac{E_e}{Q_f} = \frac{E_g - E_{au}}{Q_f} \quad (3)$$

where E_e (MWe) is the net power output of the power plant and Q_f (MWth) is the thermal energy input of the fuel, E_g (MWe) is the gross power output from turbines and E_{au} (MWe) is the total auxiliary load including plant operation and consumption and the transformer losses. It should be noted that all the values of η and thermal energy input of the fuel in this study are LHV based.

There are two rationales to evaluate the efficiency of a power plant when a CCS system is integrated.

- (i) E_e is fixed to meet the end user demand while increasing the feeding rate of fuel to compensate for the power output loss incurred by the CCS system. Increasing the fuel feeding rate may require changing the dimension and capacity of the boiler or lead to different steam conditions. Therefore this rationale is more suitable for a new power plant to be built with CO₂ capture;
- (ii) Q_f is fixed while the net power output is re-evaluated when the CO₂ capture system is integrated. This rationale is more suitable for retrofitting an existing power plant to integrate the CCS system. It is also more applicable for NGCC case as the capacities of NGCC power plants are determined by the fixed outputs of the commercially available gas turbines.

The PC case with the MEA system in NETL (2010) used rationale (i) while in this study the PC case with the PEI/silica adsorbent based capture system uses rationale (ii). Rationale (ii) is used for the NGCC cases in both NETL (2010) and this study.

For the cases where CO₂ capture is integrated, the net plant efficiency can be expressed as:

$$\eta_c = \frac{E_e^c}{Q_f} = \frac{E_g^c - E_{au}^c - E_{cap} - E_{com}}{Q_f} \quad (4)$$

where E_{cap} (MWe) is the electrical energy required for the operation of the CCS system; E_{com} (MWe) is the electrical energy required

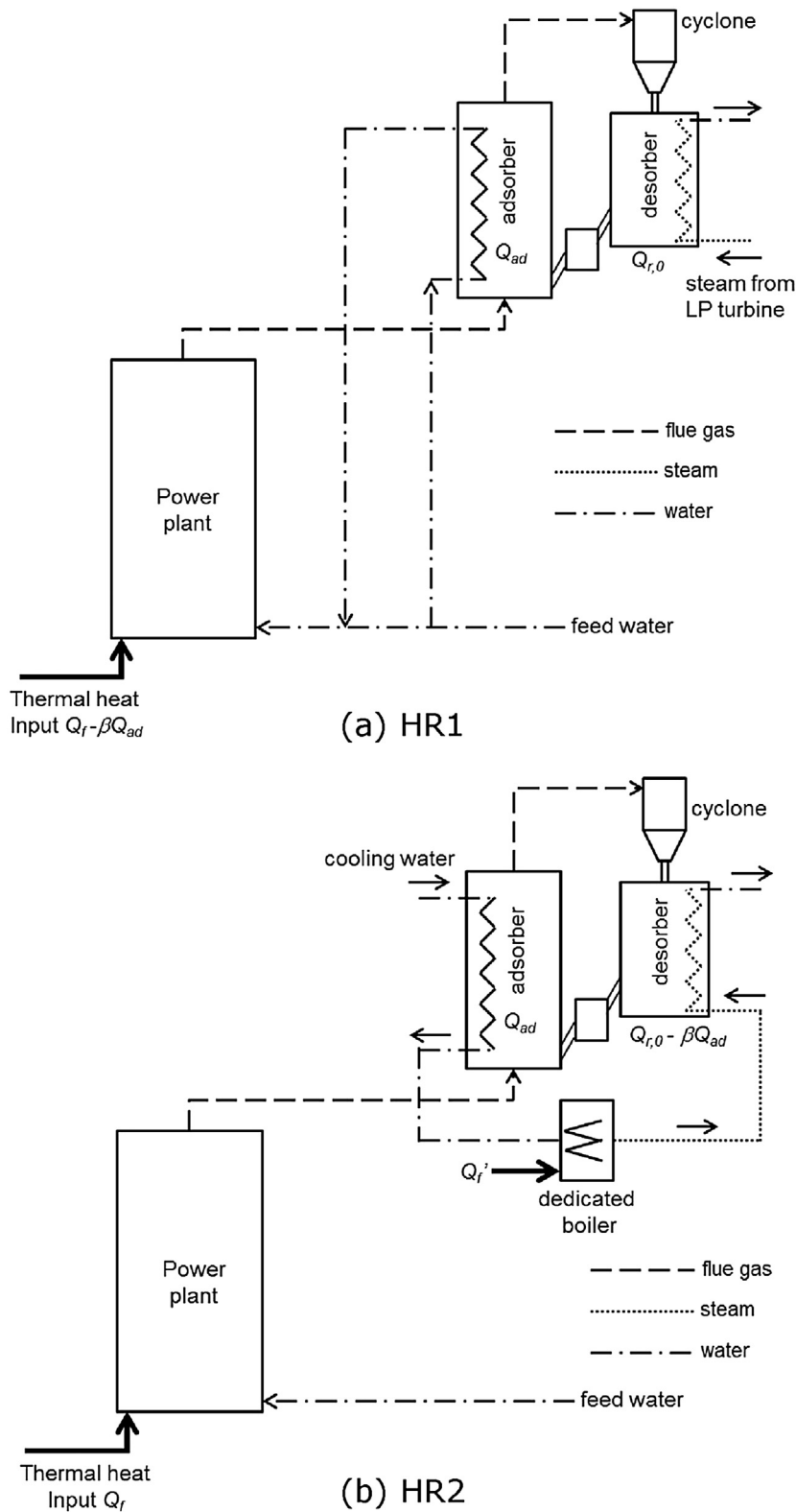

Fig. 4. Options of heat recovery strategies for heat of adsorption and energy supplies for regeneration (a) HR1: heat of adsorption is recovered to reduce the thermal energy input; (b) HR2: heat of adsorption is recovered to reduce the regeneration heat.

to compress the CO₂ product gas to the desired pressure for transportation and storage. Transportation and subsequent storage costs of the CO₂ product gas are not considered in this study following the same methodology of the NETL (2010). The gross power output E_g^c with CO₂ capture is reduced compared to the original power plant

as the extracted steam from LP turbines is used to provide the thermal heat for the regeneration process. The thermal energy input Q_f is assumed to be effectively reduced by recovering a portion of heat of adsorption using heat recovery strategy option 1 (HR1).

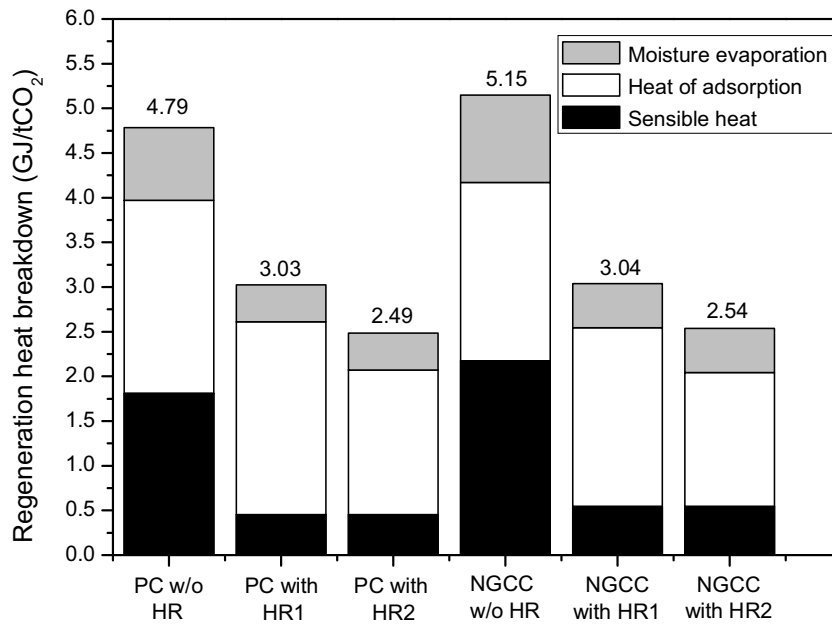

Fig. 5. Regeneration heat breakdowns for PC and NGCC capture plants with and without heat recovery (numbers above columns indicate the total regeneration heat for each case).

Table 4
Steam/water conditions and properties (data shown are for each unit of desorber).

	PC	NGCC
Saturated steam into BFB desorber		
Pressure (bar)	5.069	5.069
Temperature (K)	425.4	425.4
Specific enthalpy (kJ/kg)	2748.7	2748.7
Mass flow rate in the sweep gas (kg/s)	1.2	0.68
Mass flow rate required for regeneration (kg/s)	79.9	37.0
Condensed water		
Pressure (bar)	9.214	5.069
Temperature (K)	424.1	424.1
Specific enthalpy (kJ/kg)	637.3	636.8
Extracted steam from LP		
Pressure (bar)	5.069	5.172
Temperature (K)	564.3	611.6
Specific enthalpy (kJ/kg)	3046.4	3144.1
Mass flow rate extracted for LP turbine (kg/s)	71.1	31.7

The efficiency penalty of a power plant with CCS compared with the original power plant without CCS can then be defined as the difference in net plant efficiencies:

$$\Delta\eta = \eta - \eta_c \quad (5)$$

4.2. Power plant output losses

The conditions and properties of steam and water used in the proposed capture system are listed in Table 4. The steam is extracted from the cross-over pipe between the intermediate pressure (IP) and LP steam turbine sections. The conditions of this extracted superheated steam (pressure, temperature) are the same with those defined by the reference power plants (NETL, 2010). A portion of the condensed water is recirculated to mix with and cool down the superheated steam to the saturation condition. The main stream of the saturated steam enters the heat exchangers in the desorber to provide regeneration heat while a small fraction of the steam is flashed to the lower pressure required for fluidizing adsorbent particles in the BFB desorber and then it is fed into the BFB desorber together with the recirculated CO₂ to serve as the sweep gas. Power outputs of different steam turbines are also listed

Table 5
Turbine power outputs and gross plant power.

	PC	NGCC
LP turbine power output (MW)	235.6 (w/o) 150.7 (CCS)	102.2 (w/o) 55.7 (CCS)
IP turbine power output (MW)	172.8	60.4
HP turbine power output (MW)	180.7	46.9
Total steam turbine power output (MW)	589.1 (w/o) 504.2 (CCS)	210.0 (w/o) 163 (CCS)
Generator efficiency (%)	98.5	96.6
Gas turbine power (MW)	–	362.2
Gross plant power (MW)	580.3 (w/o) 496.6 (CCS)	564.7 (w/o) 519.7 (CCS)
Gross plant power loss with CCS (MW)	83.7	46.4

in Table 5. Comparing with the cases without CCS, the integration of the CO₂ capture system has induced a power loss in LP turbines due to the extraction of steam. The reduction in gross power output is 83.7 MW for PC/CCS case and 46.4 MW for NGCC/CCS case.

The breakdown of power losses in Eq. (4), i.e. CO₂ compression power consumption, capture system auxiliaries' power consumption, LP power output loss resulted from steam extraction and the original plant auxiliaries' power consumption have been assessed for PC/CCS and NGCC/CCS cases with the proposed capture system and compared with the original power plant and the power plant integrated with the advanced MEA based system (NETL, 2010). As illustrated in Fig. 6, for both PC and NGCC power plants, the proposed CCS system has significantly reduced the power losses from LP turbines, owing to the smaller amount of extracted steam required for regeneration of the solid adsorbent comparing with the reference advanced MEA cases. The calculated capture system auxiliaries' load for the proposed CCS system is however slightly higher than the advanced MEA system due to the higher demand of electrical energy to drive the fans and circulate the solid adsorbent within the loop. It can also be concluded from Fig. 6 that all NGCC cases with or without CO₂ capture have much lower power losses than the corresponding PC cases. The total power losses for NGCC PEI/silica case are comparable to the NGCC advanced MEA case. The big difference between the PC advanced MEA case and the PC PEI case is mostly due to the fact that the PC advanced MEA

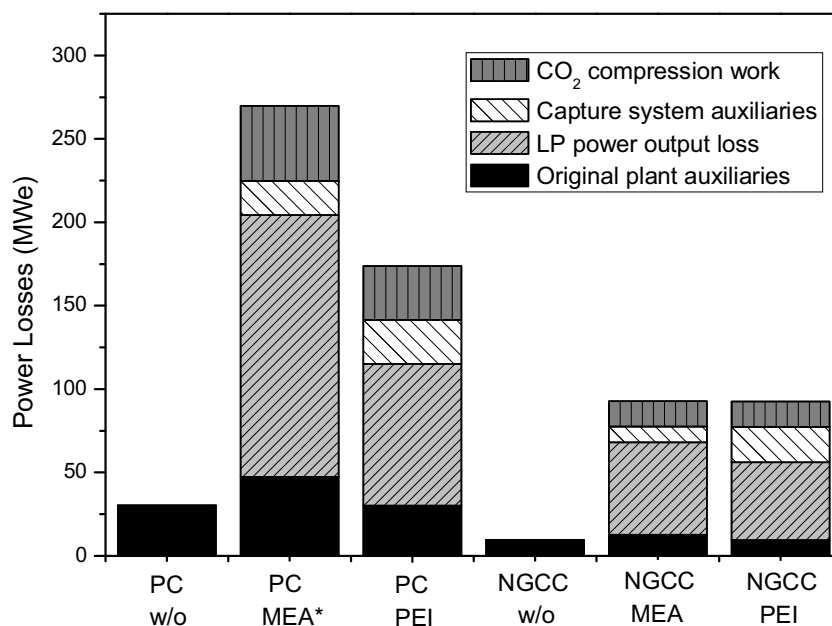

Fig. 6. Comparison of power losses for PC and NGCC power plants with and without the CCS system (*PC advanced MEA case uses rationale (i)).

Table 6
Simulation results for PC power plants w/o and with CO₂ capture.

Power Plant data	Spence ^a simulation by Veneman et al. (2013)			NETL (2010)		this study
	w/o	MEA	SAS	w/o	MEA ^a	PEI
Thermal energy input by coal (MWth)	2307.3	2307.3	2307.3	1400.2	1934.5	1321
Gross plant power (MWe)	1116.7	935.9	1031.8	580.4	662.8	496.6
Plant own consumption (MWe)	45.9	46.0	45.9	28.6	45.1	28.6
Transformer losses (MWe)	2.1	1.6	1.8	1.82	2.3	1.6
CO ₂ capture related electricity demand (MWe)	–	19.9	22.2	–	20.6	26.4
CO ₂ compression (MWe)	–	64.5	72.9	–	44.9	32.2
Net plant power (MWe)	1068.6	804.0	889.0	550	550	407.9
Net plant efficiency (%)	46.3	34.8	38.5	40.8	29.4	30.9
Relative efficiency penalty (%)	–	24.8	16.8	–	27.8	24.2
Required extra thermal energy input (% of MWth)	–	33.0	20.2	–	38.6	32.0
CO ₂ emission rate (tCO ₂ /MWh)	0.84	0.11	0.11	0.80	0.10	0.11

^a Net plant power is kept the same as original PC power plant only for this case.

case in NETL (2010) uses rationale (i) where the fuel feeding rate, as well as the gross power output, has been greatly increased.

4.3. Efficiency penalty and comparison with reference data

The net plant efficiencies of PC and NGCC power plants with the proposed CO₂ capture system are assessed and the results are summarized in Table 6 (PC) and Table 7 (NGCC). Simulation results of a PC and a NGCC power plant with CO₂ capture by MEA scrubbing and SAS (Supported Amine Sorbents) using Spence[®] software by Veneman et al. (2013) are also listed for comparison.

The net plant efficiency for the PC power plant integrated with the proposed capture system is 30.9% and the absolute efficiency penalty is 9.9% comparing with the original PC power plant without CCS. Using the advanced MEA system as the capturing technology induces an efficiency penalty of 11.4% according to the estimate by NETL (2010). Zhao et al. (2013a) had also reported a 10–14% decrease in the net plant efficiency for the optimized MEA-based absorption processes. According to a recent literature review (Rubin et al., 2015), the net plant efficiency penalties for supercritical PC plants with advanced post-combustion CCS technologies range from 7.7 to 11.9%. Whereas, a recent study by Supekar and Skerlos (2015) had concluded a much wider range of efficiency

penalties from 11.3 to 22.9% for retrofitting a 650 MWe subcritical PC plant with the advanced MEA based CCS system. The higher end of 22.9% was derived under a strict representative scenario with assumptions of 1) there is no heat recovery; 2) steam extraction from turbine is not feasible thus a dedicated coal-fired boiler is needed to supply the regeneration heat; 3) additional devices and associated energy input are needed for removal of flue gas contaminants. The uncertainties arising from adopting different scenarios have led to disputes (Herzog et al., 2016; Supekar and Skerlos, 2016). Further assessment of the efficiency penalty is needed to eliminate the uncertainties by developing more advanced processes and learning experiences from worldwide demonstration CCS projects.

As the thermal heat input and the net plant power output are different for each case, a term of “relative efficiency penalty” is defined as “the ratio between the net efficiency penalty and the original plant efficiency”. The calculated relative efficiency penalty for the proposed capture system for the PC plant is 24.2%, comparing to 27.8% for the advanced MEA system in NETL (2010). For the SAS case in Veneman’s simulation (Veneman et al., 2013), the efficiency penalty was estimated to be 7.8%, which is lower than the penalty of the PEI/silica based CCS system investigated in this study (9.9%). The net plant efficiency of the proposed CCS system for the PC case

Table 7
Simulation results for NGCC power plants w/o and with CO₂ capture.

Power Plant data	Spence [®] simulation by Veneman et al. (2013)			NETL (2010)		this study
	w/o	MEA	SAS	w/o	MEA	PEI
Thermal energy input by natural gas (MWth)	756.7	756.7	756.7	997	997	984.4
Gross plant power (MWe)	452.4	408.2	431.1	564.7	511.0	519.7
Plant own consumption (MWe)	6.0	5.1	5.6	7.9	11.0	7.9
Transformer losses (MWe)	0.9	0.8	0.8	1.7	1.6	1.6
CO ₂ capture related electricity demand (MWe)	–	6.0	15.3	–	9.6	21.3
CO ₂ compression (MWe)	–	12.1	13.6	–	15.2	15.1
Net plant power (MWe)	445.5	384.2	395.8	555	473.6	473.8
Net plant efficiency (%)	58.9	50.8	52.3	55.7	47.5	48.1
Relative efficiency penalty (%)	–	13.8	11.2	–	14.7	13.5
Required extra thermal energy input (% of MWth)	–	16.0	12.7	–	16.2	15.6
CO ₂ emission rate (tCO ₂ /MWh)	0.37	0.04	0.04	0.36	0.04	0.04

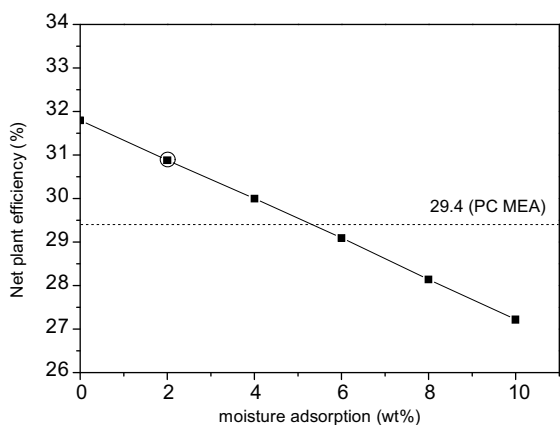

(a) Effect of moisture adsorption on net plant efficiency

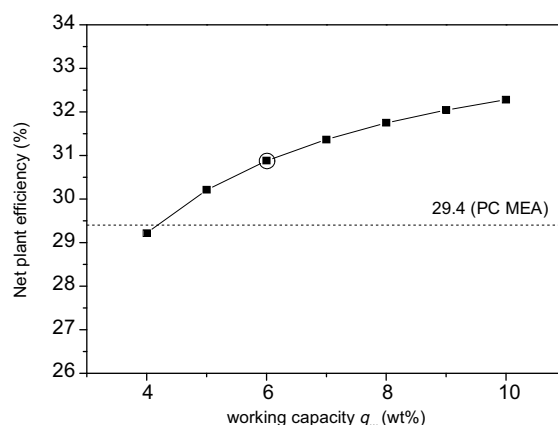

(b) Effect of working capacity on net plant efficiency

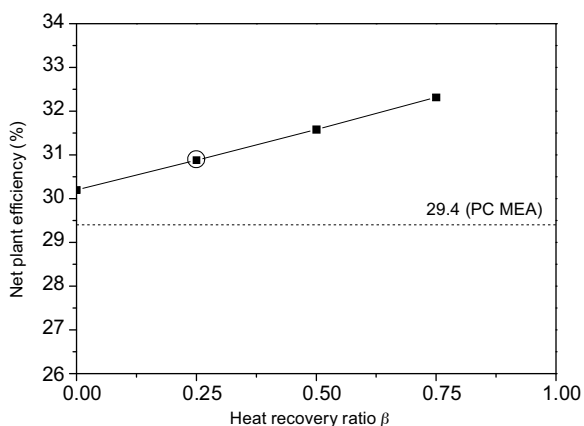

(c) Effect of heat recovery ratio β on net plant efficiency

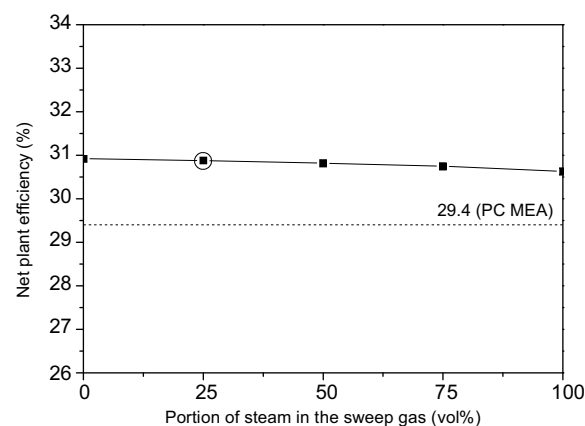

(d) Effect of portion of steam in the sweep gas on net plant efficiency

Fig. 7. Sensitivity analysis of the important parameters affecting the net plant efficiency for PC power plant integrated with the proposed CCS system (data point with a circle around indicates the value with nominated assumptions listed in Table 1).

in this study is 1.5% (absolute) higher than the advanced MEA system. As mentioned earlier in Section 2, we are using conservative but more practical assumptions for the adsorbent properties associated with a practical process such as the heat of adsorption and the working capacities. Our measured data of heat of adsorption are higher than most of the reported values. The more conservative however practical heat recovery strategy (HR1) of recovering the heat of adsorption is also used in this study. These factors have led to a higher regeneration heat of 3.03 GJ/tCO₂ (PC) or 3.04 GJ/tCO₂

(NGCC) comparing with 1.8 GJ/tCO₂ estimated by Veneman et al. (2013). The required extra thermal heat input in Tables 6 and 7 is calculated on the condition that more fuel needs to be consumed in order to maintain the net plant power output to be the same as that of the original power plant.

The net plant efficiency for the NGCC power plant integrated with the proposed PEI/silica based CCS system is 48.1% and the absolute efficiency penalty comparing with the original NGCC power plant without CCS is 7.6%, which represents 0.6% improve-

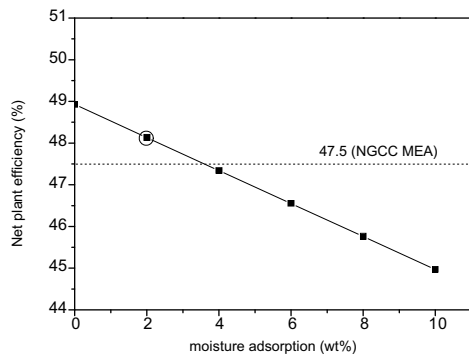

(a) Effect of moisture adsorption on net plant efficiency

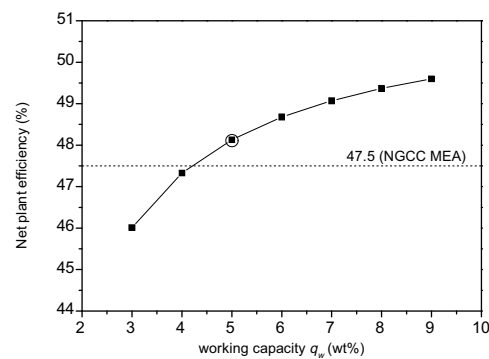

(b) Effect of working capacity on net plant efficiency

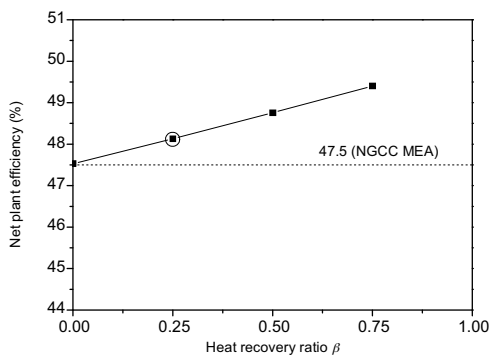

(c) Effect of heat recovery ratio β on net plant efficiency

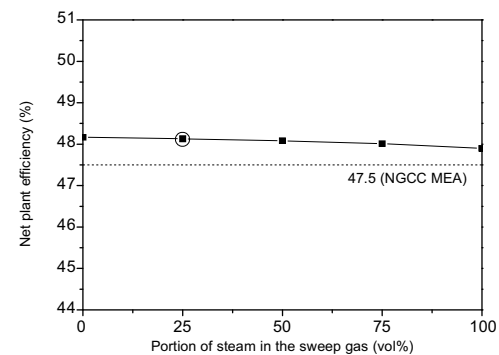

(d) Effect of portion of steam in the sweep gas on net plant efficiency

Fig. 8. Sensitivity analysis of the important parameters affecting the net plant efficiency for NGCC power plant integrated with the proposed CCS system (data point with a circle around indicates the value with nominated assumptions listed in Table 1).

ment in the net plant efficiency comparing with the advanced MEA system in NETL (2010). By retrofitting CO₂ capture facilities with the target capture efficiency of 90%, the CO₂ emission rates have significantly reduced from 0.80 to 0.11 tCO₂/MWh (PC cases) and from 0.36 to 0.04 tCO₂/MWh (NGCC cases). The CO₂ emission rates for NGCC cases are much lower than those for PC cases because of the higher heating value of natural gas, the lower carbon intensity of natural gas relative to coal, and the higher overall efficiency of NGCC power plants.

4.4. Sensitivity analysis on the net plant efficiency

Due to the lack of investigations on the process-related parameters associated with a solid adsorbent based CCS system, it is still difficult to give an accurate estimation of the net plant efficiency considering potential uncertainties involved in this study. From the parametric analysis of the factors affecting regeneration heat (Zhang et al., 2016), working capacity and moisture adsorption were identified as the two most influential parameters. Their effects on the net plant efficiencies for both PC and NGCC power plants with CCS are also evaluated in this study and the results are illustrated in Fig. 7 (PC) and Fig. 8 (NGCC), where the net plant efficiency for the advanced MEA based system is used as a reference for comparison.

Moisture co-adsorption in the CFB adsorber and its subsequent vaporization in the BFB desorber have a crucial effect on the overall regeneration heat and the net plant efficiency. However, only a few investigations (Quang et al., 2014; Veneman et al., 2015) have addressed this issue at the process level. The amount of adsorption, as well as the physical state of the moisture during adsorption

and desorption, are still not completely understood. By assuming that the moisture is adsorbed in liquid state in the adsorber and desorbed totally in the desorber in vapour state, the effects of moisture adsorption capacity on the net plant efficiencies for both PC and NGCC cases have been evaluated as shown in Figs. 7(a) and 8(a), respectively. If the moisture adsorption capacity is higher than 5 wt% for the PC case or 4 wt% for the NGCC case, the estimated net plant efficiency for the solid adsorbent based CCS systems would be no better than the advanced MEA based system (NETL, 2010). Therefore, the strategies that can restrict the moisture adsorption in the adsorber or moisture vaporization in the desorber such as surface modifications to enhance the hydrophobicity or controlling adsorbent residence times in the adsorber and desorber can enhance the advantages of a solid adsorbent based CCS system.

High equilibrium CO₂ adsorption capacities have been the main target of the recent efforts on material development while the working capacity of a specific solid adsorbent in a continuous CO₂ adsorption system has only been studied by a few groups of researchers recently (Sjostrom et al., 2011; Zhao et al., 2013b; Breault et al., 2016). Increasing working capacity can reduce the required solid circulating rate which in turn reduces the required regeneration heat, as well as the electrical energy to circulate the solid adsorbent and therefore the efficiency penalty. Based on the proposed system using the PEI/silica adsorbent, the estimated net plant efficiency becomes lower than the advanced MEA system if the working capacity is lower than 4 wt% (Figs. 7(b) and 8(b)), which might be regarded as the minimum requirement for a solid adsorbent based CCS system to be more advantageous than the advanced MEA system. It should also be noted that, as revealed in Figs. 7(b) and 8(b), the parabolic alike curves imply that further improvement

in the working capacity can only gradually increase the net plant efficiency.

The comprehensive investigation into a solid adsorbent based CO₂ capture system at a process level is still at its initial research stage. It is noteworthy that the two most important process-relevant parameters (working capacity and moisture adsorption) in this study are subject to significant improvements by the foreseeable technology developments. Under an optimal scenario which can be achieved in the near future with potential enhancement of 2% points in working capacity and 1% point reduction in moisture adsorption, the net plant efficiencies for the proposed systems are expected to be 2.7% (PC case) and 1.9% (NGCC case) points higher than the reference advanced MEA systems.

As discussed earlier, the recovery of heat of adsorption in the CFB adsorber is the most challenging task that can effectively reduce the plant efficiency penalty. The ratio of heat recovery depends largely on the available heat exchange facilities and optimized process configurations. Current investigations on a specifically designed process and system for solid adsorbents are very limited except for those published very recently (Kim et al., 2014a,b; Proll et al., 2016; Schony et al., 2016; Veneman et al., 2016). As shown in Figs. 7(c) and 8(c), even without any recovery of heat of adsorption ($\beta=0$), the net plant efficiency for either the PC or the NGCC case with the proposed CCS system is still higher than or comparable to the advanced MEA system. Improvement and optimization in the process design with a higher recovery ratio (β) of heat of adsorption, such as the multi-stage fluidized bed system proposed by Kim et al. (2014b), can potentially result in a significant increase in the net plant efficiency.

Figs. 7(d) and 8(d) have also revealed that increasing the portion of steam in the sweep gas from 25% to 100% only leads to a very small reduction in the net plant efficiency for either the PC or the NGCC case, which is due to the fact that the steam flow rate required for sweep gas use is much smaller than that for the regeneration use (Table 4). This implies that using pure steam as the sweep gas might be a more promising regeneration strategy considering that steam regeneration will not cause severe problems of degradation, in contrast to the regeneration strategy using CO₂ as the sweep gas (Serna-Guerrero et al., 2010; Veneman et al., 2012; Hoffman et al., 2014; Gray et al., 2009; Li et al., 2010a). Apart from the material and process development to achieve higher working capacity and lower moisture adsorption, process related improvements and optimization such as more energy efficient recovery strategies are crucial to further minimize the plant efficiency penalty.

5. Conclusions

Post-combustion carbon capture systems using fluidized bed technologies and a PEI/silica solid adsorbent for a supercritical 550 MWe PC and 555 MWe NGCC power plants have been conceptually designed and the effects of integrating the carbon capture system on the net plant efficiency have been evaluated by process simulations. Based on the proposed heat recovery strategy for the heat of adsorption and the CFB/BFB coupled carbon capture system, the efficiency penalties have been estimated and compared with the reference advanced MEA system (NETL, 2010) and another solid adsorbent based capturing process (Veneman et al., 2013). The net plant efficiency of the PC and NGCC power plant with the proposed capture system is found to be 1.5% and 0.6% point higher than the reference PC and NGCC systems, respectively. These efficiency advantages of the proposed carbon capture system using PEI/silica adsorbent have been obtained with the conservative nominated parameters assumed in this study. Improvements in working capacities and restriction of moisture adsorption in the CFB adsorber, as well as development of more energy efficient recovery

strategies and process optimizations, are expected to be able to further improve the plant efficiency. Under an optimal scenario with improvements in increasing the working capacity by 2% points and decreasing moisture adsorption by 1% point, the plant efficiencies with the proposed capture system are 2.7% (PC) and 1.9% (NGCC) points higher than the reference systems.

Acknowledgement

This work was supported by the UK Engineering and Physical Sciences Research Council [grant numbers EP/J020745/1 and EP/G063176/1].

References

- Abanades, J.C., Arias, B., Lyngfelt, A., Mattisson, T., Wiley, D.E., Li, H., Ho, M.T., Mangano, E., Brandani, S., 2015. Emerging CO₂ capture systems. *Int. J. Greenh. Gas Control* 40, 126–166.
- Abu-Zahra, M.R.M., Schneiders, L.H.J., Niederer, J.P.M., Feron, P.H.M., Versteeg, G.F., 2007. CO₂ capture from power plants: part I. A parametric study of the technical performance based on monoethanolamine. *Int. J. Greenh. Gas Control* 1, 37–46.
- ADA Report, Topical Report 1, 2 and 3: Technology Survey, Screening and Final Selection. DOE Award No. DE-NT0005649, Project Director: Sjoström, S., Issued on July 2010.
- Alie, C., Backham, L., Croiset, E., Douglas, P., 2005. Simulation of CO₂ capture using MEA scrubbing: a flowsheet decomposition method. *Energy Convers. Manage.* 46, 475–487.
- Amrollahi, Z., Ystad, P.A.M., Ertesvag, I.S., Bolland, O., 2012. Optimized process configurations of post-combustion CO₂ capture for natural-gas-fired power plant—power plant efficiency analysis. *Int. J. Greenh. Gas Control* 8, 1–11.
- Bashadi, S., 2010. Using Auxiliary Gas Power for CCS Energy Needs in Retrofitting Coal Power Plants. Massachusetts Institute of Technology (Master thesis).
- Basu, P., 2006. Combustion and gasification in fluidized beds. In: Chapter 8: Circulating Fluidized Bed Boiler.
- Belmabkhout, Y., Sayari, A., 2009. Effect of pore expansion and amine functionalization of mesoporous silica on CO₂ adsorption over a wide range of conditions. *Adsorption* 15, 318–328.
- Berstad, D., Arasto, A., Jordal, K., Haugen, G., 2011. Parametric study and benchmarking of NGCC, coal and biomass power cycles integrated with MEA-based post-combustion CO₂ capture. *Energy Procedia* 9, 1737–1744.
- Breault, R.W., Spenik, J.L., Shadle, L.J., Hoffman, J.S., Gray, M.L., Panday, R., Stehle, R.C., 2016. Carbon capture test unit design and development using amine-based solid sorbent. *Chem. Eng. Res. Des.* 112, 251–262.
- Chaffee, A.L., Knowles, G.P., Liang, Z., Zhang, J., Xiao, P., Webley, P.A., 2007. CO₂ capture by adsorption: materials and process development. *Int. J. Greenh. Gas Control* 1, 11–18.
- Chapel, D., Ernest, J., Mariz, C., 1999. Recovery of CO₂ from flue gases: commercial trends. In: Canadian Society of Chemical Engineers Annual Meeting, October 4–6, Canada.
- Choi, S., Drese, J.H., Jones, C.W., 2009. Adsorbent materials for carbon dioxide capture from large anthropogenic point sources. *ChemSusChem* 2, 796–854.
- Cousins, A., Wardhough, L.T., Feron, P.H.M., 2011. A survey of process flow sheet modifications for energy efficient CO₂ capture from flue gases using chemical absorption. *Int. J. Greenh. Gas Control* 5, 605–619.
- Dave, N., Do, T., Palfreyman, D., Feron, P.H.M., 2011. Impact of post combustion capture of CO₂ on existing and new Australia coal-fired power plants. *Energy Procedia* 4, 2005–2019.
- Drage, T.C., Arenillas, A., Smith, K.M., Snape, C.E., 2008. Thermal stability of polyethyleneimine based carbon dioxide adsorbents and its influence on selection of regeneration strategies. *Microporous Mesoporous Mater.* 116, 506–512.
- Dutcher, B., Fan, M., Russell, A.G., 2015. Amine-based CO₂ capture technology development from the beginning of 2013—a review. *ACS Appl. Mater. Interfaces* 7, 2137–2148.
- EBTP, Zero Emissions Platform Report: Biomass with CO₂ Capture and Storage (Bio-CCS), 2012: 4–29.
- EPA, [Online]: <http://www.epa.gov/climatechange/ghgemissions/gases/co2.html>. (Accessed February 2016).
- Ebner, A.D., Gray, M.L., Chisholm, N.G., et al., 2011. Suitability of a solid amine sorbent for CO₂ capture by pressure swing adsorption. *Ind. Eng. Chem. Res.* 50, 5634–5641.
- Goto, K., Yogo, K., Higashii, T., 2013. A review of efficiency penalty in a coal-fired power plant with post-combustion CO₂ capture. *Appl. Energy* 111, 710–720.
- Gray, M.L., Hoffman, J.S., Hreha, D.C., et al., 2009. Parametric study of solid amine sorbents for the capture of carbon dioxide. *Energy Fuels* 23, 4840–4844.
- Hammache, S., Hoffman, J.S., Gray, M.L., Fauth, D.J., Howard, B.H., Pennline, H.W., 2013. Comprehensive study of the impact of steam on polyethyleneimine on silica for CO₂ capture. *Energy Fuels* 27, 6899–6905.

- Han, C., Graves, K., Neathery, J., Liu, K., 2011. Simulation of the energy consumption of CO₂ capture by aqueous monoethanolamine in pilot plant. *Energy Environ. Res.* 1, 67–80.
- Haszeldine, R.S., 2009. Carbon capture and storage: how green can black be? *Science* 325, 1647–1652.
- Hedin, N., Anderson, L., Bergstrom, L., Yan, J., 2013. Adsorbents for post-combustion capture of CO₂ using rapid temperature swing or vacuum swing adsorption. *Appl. Energy* 104, 418–433.
- Heesink, A.B.M., Veneman, R., Magneschi, G., Brilman, D.W.F., Cutting the cost of carbon capture. *Power Engineering International*, 05/09/2013. <http://www.powerengineeringint.com/articles/print/volume-21/issue-8/power-generation-best-paper-award-winners/cutting-the-cost-of-carbon-capture.html>.
- Herzog, H.J., Rubin, E.S., Rochelle, G.T., 2016. Comment on "Reassessing the efficiency penalty from carbon capture in coal-fired power plants". *Environ. Sci. Technol.* 50, 6112–6113, <http://dx.doi.org/10.1021/acs.est.6b00169>.
- Hoffman, J.S., Hammache, S., Gray, M.L., Fauth, D.J., Pennline, H.W., 2014. Parametric study for an immobilized amine sorbent in a regenerative carbon dioxide capture process. *Fuel Process. Technol.* 126, 173–187.
- IEA, 2011. Cost and Performance of Carbon Dioxide Capture from Power Generation. Working paper by International Energy Agency.
- IEA, 2015. World Energy Outlook 2015 (WEO-2105), released on 10 November.
- Glier, Justin C., Rubin, Edward S., 2013. Assessment of solid sorbents as a competitive post-combustion CO₂ capture technology. *Energy Procedia* 37, 65–72.
- Khalilpour, R., Abbas, A., 2011. HEN optimization for efficient retrofitting of coal-fired power plants with post-combustion carbon capture. *Int. J. Greenh. Gas Control* 5, 189–199.
- Kim, K., Park, Y., Park, J., Jung, E., Seo, H., Kim, H., Lee, K.S., 2014a. Performance comparison of moving and fluidized bed sorption systems for an energy-efficient solid sorbent-based carbon capture process. *Energy Procedia* 63, 1151–1161.
- Kim, K., Kim, D., Park, Y., Lee, K.S., 2014b. A solid sorbent-based multi-stage fluidized bed process with inter-stage heat integration as an energy efficient carbon capture process. *Int. J. Greenh. Gas Control* 26, 135–146.
- Krutka, H., Sjöstrom, S., Starns, T., Dillon, M., Silverman, R., 2013. Post-combustion CO₂ capture using solid sorbents: 1 MWe pilot evaluation. *Energy Procedia* 37, 73–88.
- Li, W., Choi, S., Drese, J.H., Hornbostel, M., Krishnan, G., Eisenberger, P.M., Jones, C.W., 2010a. Steam-stripping for regeneration of supported amine-based CO₂ adsorbents. *ChemSusChem* 3, 899–903.
- Li, W., Bollini, P., Didas, S.A., Choi, S., Drese, J.H., Jones, G.W., 2010b. Structural changes of silica mesocellular foam supported amine-functionalized CO₂ adsorbents upon exposure to steam. *ACS Appl. Mater. Interfaces* 2, 3363–3372.
- Li, K., Leigh, W., Feron, P., Yu, H., Tade, M., 2016. Systematic study of aqueous monoethanolamine (MEA)-based CO₂ capture process: techno-economic assessment of the MEA process and its improvements. *Appl. Energy* 165, 648–659.
- Liebhenthal, U., Linnenberg, S., Oexmann, J., Kather, A., 2011. Derivation of correlations to evaluate the impact of retrofitted post-combustion CO₂ capture processes on steam power plant performance. *Int. J. Greenh. Gas Control* 5, 1232–1239.
- Manzolini, G., Fernandez, E.S., Rezvani, S., Macchi, E., Goetheer, E.L.V., Vlucht, T.J.H., 2015. Economic assessment of novel amine based CO₂ capture technologies integrated in power plants based on European Benchmarking Task Force methodology. *Appl. Energy* 138, 546–558.
- Middleton, R.S., Eccles, J.K., 2013. The complex future of CO₂ capture and storage: variable electricity generation and fossil fuel power. *Appl. Energy* 108, 66–73.
- Mondal, M.K., Balsora, H.K., Varshney, P., 2012. Progress and trends in CO₂ capture/separation technologies: a review. *Energy* 46, 431–441.
- NETL, Cost and performance baseline for fossil energy plants, Volume 1: bituminous coal and natural gas to electricity. Revision 2, November 2010, DOE/NETL-2010/1397.
- Pirngruber, G.D., Guillou, F., Gomez, A., Clausse, M., 2013. A theoretical analysis of the energy consumption of post-combustion CO₂ capture processes by temperature swing adsorption using solid sorbents. *Int. J. Greenh. Gas Control* 14, 74–83.
- Popa, A., Edwards, R., Aandi, I., 2011. Carbon capture considerations for combined cycle gas turbine. *Energy Procedia* 4, 2315–2323.
- Proll, T., Schony, G., Sprachmann, G., Hofbauer, H., 2016. Introduction and evaluation of a double loop staged fluidized bed system for post-combustion CO₂ capture using solid sorbents in a continuous temperature swing adsorption process. *Chem. Eng. Sci.* 141, 166–174.
- Quang, D.V., Dindi, A., Rayer, A.V., Hadri, N.E., Abdulkadir, A., Abu-Zahra, M.R.M., 2014. Effect of moisture on the heat capacity and the regeneration heat required for CO₂ capture process using PEI impregnated mesoporous precipitated silica. *Greenh. Gas Sci. Technol.*, 1–11.
- Raksajati, A., Ho, M.T., Wiley, D.E., 2013. Reducing the cost of CO₂ capture from flue gases using aqueous chemical absorption. *Ind. Eng. Chem. Res.* 52, 16887–16901.
- Reddy, S., Johnson, D., Gilmartin, J., 2008. Fluor's econamine FG PlusSM technology for CO₂ capture at coal-fired power plants. In: *Power Plant Air Pollutant Control "Mega" Symposium*, Baltimore, MD, August.
- Rubin, E.S., Short, C., Booras, G., Davison, J., Ekstrom, C., Matuszewski, M., McCoy, S., 2013. A proposed methodology for CO₂ capture and storage cost estimates. *Int. J. Greenh. Gas Control* 17, 488–503.
- Rubin, E.S., Davison, J.E., Herzog, H.J., 2015. The cost of CO₂ capture and storage. *Int. J. Greenh. Gas Control* 40, 378–400.
- Samanta, A., Zhao, A., Shimizu, G.K.H., Sarkar, P., Gupta, R., 2012. Post-combustion CO₂ capture using solid sorbents: a review. *Ind. Eng. Chem. Res.* 51, 1438–1463.
- Sanpasertparnich, T., Idem, R., Bolea, I., deMontigny, D., Tontiwachwuthikul, P., 2010. Integration of post-combustion capture and storage into a pulverized coal-fired power plant. *Int. J. Greenh. Gas Control* 4, 499–510.
- Schony, G., Zehetner, E., Fuchs, J., Proll, T., Sprachmann, G., Hofbauer, H., 2016. Design of a bench scale unit for continuous CO₂ capture via temperature swing adsorption – fluid-dynamic feasibility study. *Chem. Eng. Res. Des.* 106, 155–167, <http://dx.doi.org/10.1016/j.cherd.2015.12.018>.
- Serna-Guerrero, R., Belmabkhout, Y., Sayari, A., 2010. Influence of regeneration conditions on the cyclic performance of amine-grafted mesoporous silica for CO₂ capture: an experimental and statistical study. *Chem. Eng. Sci.* 65, 4166–4172.
- Singh, D., Croiset, E., Douglas, P., Douglas, M., 2003. Techno-economic study of CO₂ capture from an existing coal-fired power plant: MEA scrubbing vs. O₂/CO₂ recycle combustion. *Energy Convers. Manage.* 44, 3073–3091.
- Sjöstrom, S., Krutka, H., 2010. Evaluation of solid sorbents as a retrofit technology for CO₂ capture. *Fuel* 89, 1298–1306.
- Sjöstrom, S., Krutka, H., Starns, T., Campbell, T., 2011. Pilot test results of post-combustion CO₂ capture using solid sorbents. *Energy Procedia* 4, 1584–1592.
- Son, W.J., Choi, J.K., Ahn, W.S., 2008. Adsorptive removal of carbon dioxide using polyethyleneimine-loaded mesoporous silica materials. *Microporous Mesoporous Mater.* 113, 31–40.
- Starns, T., Sjöstrom, S., Krutka, H., Wilson, C., Ivie, M., 2012. Solid Sorbents as a Retrofit CO₂ Capture Technology: Update on 1 MWe Pilot Progress, Paper# 2010-A-53-MEGA-AWMA. ADA Environmental Solutions.
- Stover, B., Bergins, C., Klebes, J., 2011. Optimized post combustion carbon capturing on coal fired power plants. *Energy Procedia* 4, 1637–1643.
- Strube, R., Manfrida, G., 2011. CO₂ capture in coal-fired power plants—impact on plant performance. *Int. J. Greenh. Gas Control* 5, 710–726.
- Supekar, S.D., Skerlos, S.J., 2015. Reassessing the efficiency penalty from carbon capture in coal-fired power plants. *Environ. Sci. Technol.* 49 (20), 12576–12584.
- Supekar, S.D., Skerlos, S.J., 2016. Response to comment on "Reassessing the efficiency penalty from carbon capture in coal-fired power plants". *Environ. Sci. Technol.*, <http://dx.doi.org/10.1021/acs.est.6b02022>.
- Veneman, R., Li, Z.S., Hogendoorn, J.A., Kersten, S.R.A., Brilman, D.W.F., 2012. Continuous CO₂ capture in a circulating fluidized bed using supported amine sorbents. *Chem. Eng. J.* 207–208, 18–26.
- Veneman, R., Kamphuis, H., Brilman, D.W.F., 2013. Post-combustion CO₂ capture using supported amine sorbents: a process integration study. *Energy Procedia* 37, 2100–2108.
- Veneman, R., Fridka, N., Zhao, W., Li, Z., Kersten, S., 2015. Adsorption of H₂O and CO₂ on supported amine sorbents. *Int. J. Greenh. Gas Control* 41, 268–275.
- Veneman, R., Hilbers, T., Brilman, D.W.F., Kersten, S.R.A., 2016. CO₂ capture in a continuous gas-solid trickle flow reactor. *Chem. Eng. J.* 289, 191–202, <http://dx.doi.org/10.1016/j.cej.2015.12.066>.
- Wang, Q., Luo, J., Zhong, Z., Borgna, A., 2011. CO₂ capture by solid adsorbents and their applications: current status and new trends. *Energy Environ. Sci.* 4, 42–55.
- Wang, J., Huang, L., Yang, R., Zhang, Z., Wu, J., Gao, Y., Wang, Q., O'Hare, D., Zhong, Z., 2014. Recent advances in solid sorbents for CO₂ capture and new development trends. *Energy Environ. Sci.* 7, 3478–3518.
- Yang, W.C., Hoffman, J., 2009. Exploratory design study on reactor configurations for carbon dioxide capture from conventional power plants employing regenerable solid sorbents. *Ind. Eng. Chem. Res.* 48, 341–351.
- Ystad, P.A.M., Bolland, O., Hillestad, M., 2012. NGCC and hard-coal power plant with CO₂ capture based on adsorption. *Energy Procedia* 23, 33–44.
- Zhang, W., Liu, H., Sun, C., Drage, T.C., Snape, C.E., 2014a. Capturing CO₂ from ambient air using a polyethyleneimine-silica adsorbent in fluidized beds. *Chem. Eng. Sci.* 116, 306–316.
- Zhang, W., Liu, H., Sun, C., Drage, T.C., Snape, C.E., 2014b. Performance of polyethyleneimine-silica adsorbent for post-combustion CO₂ capture in a bubbling fluidized bed. *Chem. Eng. J.* 251, 293–303.
- Zhang, W., Liu, H., Sun, Y., Cakstins, J., Sun, C., Snape, C.E., 2016. Parametric study on the regeneration heat requirement of an amine-based solid adsorbent process for post-combustion carbon capture. *Appl. Energy* 168, 394–405.
- Zhao, M., Minett, A.I., Harris, A.T., 2013a. A review of techno-economic models for the retrofitting of conventional pulverised-coal power plants for post-combustion capture (PCC) of CO₂. *Energy Environ. Sci.* 6, 25–40.
- Zhao, W.Y., Zhang, Z., Li, Z.S., Cai, N.S., 2013b. Continuous CO₂ capture in dual fluidized beds using silica supported amine. *Energy Procedia* 37, 89–98.