

# New communication strategy for spectrum sharing enabled smart grid cyber-physical system

Minglei You<sup>1</sup> ✉, Qitao Liu<sup>1</sup>, Hongjian Sun<sup>1</sup>

<sup>1</sup>School of Engineering and Computing Sciences, Durham University, Durham, DH1 3LE, UK

✉ E-mail: minglei.you@dur.ac.uk

ISSN 2398-3396

Received on 24th March 2017

Revised 28th June 2017

Accepted on 7th July 2017

doi: 10.1049/iet-cps.2017.0051

www.ietdl.org

**Abstract:** Smart grid cyber-physical system (CPS) exploits various physical components to provide better knowledge and delicate control of the power grid, while the huge data volume is transmitted via the integration of advanced communication technologies. To provide better services for the applications in the smart grid CPS, the communication network has to consider the aspects of both improving the system throughput and meeting the real-time requirement. In order to address this issue, a new communication strategy is proposed in this study. The strategy is based on the time performance features of different smart grid CPS applications, which also exploits both temporal and spatial available spectrum resources for transmitting via spectrum sharing techniques. Moreover, the performance has been verified by a case study based on IEEE 14-bus power system. An important real-time application, namely real-time voltage stability enhancement, has been investigated in the case study. Results show that the proposed communication strategy is able to improve the throughput of the smart grid CPS and the time performance of time sensitive applications.

## 1 Introduction

Smart grid has been considered to be the most promising solution in dealing with various challenges such as energy demand growth, voltage stability, demand response and renewable energy integration [1]. It exploits advanced communication technologies to provide bidirectional, scalable, reliable data flows between all kinds of smart devices, such as sensors, actuators and controllers. Due to this close interaction with both cyber and physical components, cyber-physical system (CPS) has been identified to be the very answer in addressing the effective and efficient integration and interaction issues in smart grids [2].

Widely implemented physical components provide more detailed grid information and more delicate control methods, while in return the data volume to be transmitted within the cyber parts is also exploding [3]. Many advanced communication techniques have been considered to provide better cyber service ability in the smart grid CPS communication network. In [4], the communication strategies for cyber-physical smart grid systems have been studied, where ‘on-demand’ strategy has been proposed to improve the performance of control-aware applications. In [5], the impact of information and communication technologies on smart grid control has been investigated via extensive case studies, where the issue of heavy communication load and the impact of communication delay have been considered. These existing literatures have also indicated that spectrum scarcity is one of the key bottlenecks of the performance improvement. In 2013, the license of a total 250 MHz was auctioned by 1.56 billion pounds for the UK companies to apply the 4G network [6]. Hence it can be expected that purchasing or leasing spectrum resources will involve huge capital investment. In contrast, although Industrial, Scientific and Medical (ISM) radio bands are free for use by everyone, it has been long reported to be over crowded where reliability and interference have been major concerns. Opportunistic transmission via cognitive radio enabled spectrum sharing technique is one of the most promising solutions. It can take advantage of spectrum vacancies for transmission, which can provide relatively much wider bandwidth than the subscribed one. Governments and organisations are working on releasing more spectrum bandwidths for communications based on spectrum sharing method. In the UK, a commitment has been announced by the government that a total of 750 MHz spectrum resources will be available by 2022, of which 500 MHz will be available by 2020 [7]. Due to such support from authorities and

organisations around the world, spectrum sharing-based communication networks become very promising methods in addressing the spectrum resource scarcity problem, especially in the smart grid CPSs where big data are expected.

The challenges are further complexed by the differentiated communication performance requirements of smart grid CPS data packages. It has been addressed that providing real-time communication services is one of the challenges for CPS applications [4]. Many applications need to make timely control decisions based on the varying measurements, where latency will compromise the performance and should be minimised. There are already researches focusing on the real-time requirement of CPSs. In [8], the IEEE time sensitive networks have been investigated in the context of cyber-physical distributed systems. In [9], the IEEE802.11-based networks have been considered to provide real-time detection of possible misbehaviours, while the real-time performance of IEEE802.11e WLAN has been studied in [10, 11]. There have been also several researches focusing on providing testbeds for smart grid CPSs [12] as well as integrating advanced wireless communication techniques such as 5G cellular networks [13]. These researches are valuable in designing communication strategies in smart grid cyber-physical communication networks. In addition, due to the features and requirements of different smart applications, the communication networks should be able to provide differentiated services. There have been several different methods proposed to address this issue. In [14], the outage performance has been investigated using dynamic spectrum management within smart grid context, where application priority has been considered. In [15], the second user priority has been considered, where blocking probability and system throughput have been studied. Different from the existing literatures, in this paper, we try to propose a more dedicated communication strategy for smart grid CPS communication networks that can generally increase the system's throughput and improve the time performance of real-time applications at the cost of intended latency for non-real-time applications, which is based on the different smart grid application time performance requirements. To be specific, the contributions of this paper are summarised as follows:

- A new communication strategy for spectrum sharing enabled smart grid CPS communication networks has been proposed,

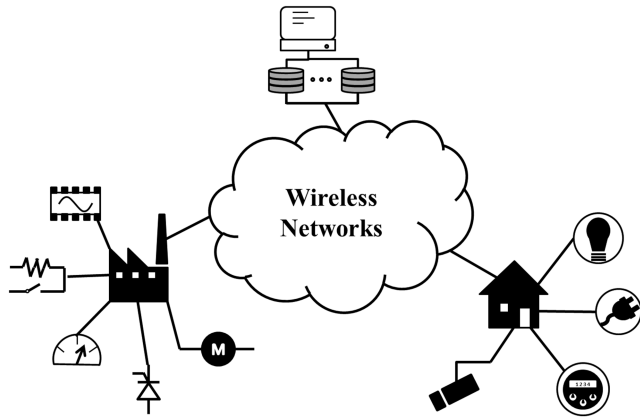

Fig. 1 Example of a smart grid CPS

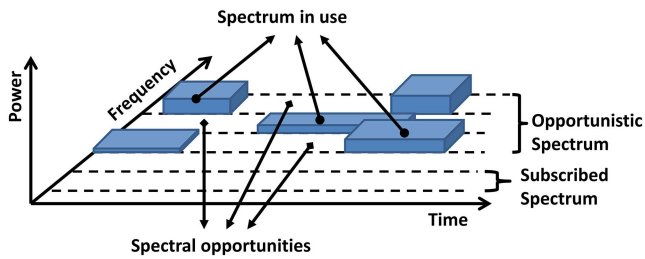

Fig. 2 Spectrum sharing via exploiting temporary unoccupied spectra

which is based on the time performance requirements of three types of smart grid applications.

- The performance gain for the proposed communication strategy has been investigated, which shows that the cyber-physical communication system performance as well as the time sensitive applications performance will be improved.
- A case study of IEEE 14-bus system has been performed, where the scenario with different types of applications are considered. Particularly, an important application, namely real-time voltage stability enhancement has been investigated under the proposed communication strategy.

The remaining of this paper is organised as follows. In Section 2, the smart grid CPSs and the applications within are briefly reviewed and categorised. After that, a communication strategy is proposed in Section 3, which is based on the time performance features of different smart grid CPS applications. In order to test the performance of the proposed communication strategy, a case study based on IEEE 14-bus power system is conducted in Section 4, where an important real-time application, namely real-time voltage stability enhancement has been investigated. Finally, conclusions are drawn in Section 5.

## 2 Spectrum sharing enabled smart grid CPSs

### 2.1 Background on smart grid CPSs

Since the term cyber-physical system was coined in 2006, it has been further developed to describe a broad range of systems that exploit multi-disciplinary technologies to address the integration and interaction between cyber and physical subsystems [16]. This system-level view of the cooperation between real-world devices and cyber space resources has also enabled the fusion of various advanced technologies, such as Internet of Things, big data, wireless sensor networks and machine-to-machine [17].

The performance of existing power grid is expected to be significantly improved via integrating all kinds of CPS sensors and devices [12]. Different from traditional power grid, these sensors and devices usually have communication abilities, which can provide real-time monitoring and control of the grid operations, such as phasor measurement units and all kinds of smart meters. Besides, advanced wireless communication techniques have been exploited to enable the bidirectional transmission within the grid.

This close interaction between physical devices and cyber components reconstructs the traditional power grid to a smart grid CPS, which has also enabled various real-time optimisation, automation and control methods to be applicable. An example of a smart grid CPS is given in Fig. 1.

Although wired networks can provide reliable, low latency and high throughput connections for the cyber networks, the cost and deployment have been the major concerns to the application in smart grid CPS. Compared to the wired counterparts, wireless communication networks have many advantages, especially in the aspects of scalability and cost. Moreover, it is much easier to update the wireless systems where various mature techniques such as cellular networks, satellite networks, *ad-hoc* networks and sensor networks available for different cover range requirements and application requirements. These features are especially important in enabling the ubiquitous connections between geographical apart physical devices. Hence in smart grid CPS, the wireless networks have been used to span the ranges. In this paper, we try to address two major concerns in improving the wireless communication networks in smart grid CPS, namely the throughput and real-time performance. The former will be addressed via spectrum sharing method discussed in Section 2.2, while the later will be improved via a new priority-based communication strategy detailed in Sections 2.3 and 3.

### 2.2 Spectrum opportunities

The limited spectrum resources have long been the bottleneck of most communication network. This is also true in the smart grid CPS. Along with the emerging of more and more smart grid applications, the conflict between high demand of communication throughput and scarcity of spectrum is becoming prominent. Since exclusive usage for a certain bandwidth usually involves huge capital investment, one very promising solution is to exploit the opportunistic transmissions via cognitive radio techniques. As demonstrated in Fig. 2, due to the ineffectiveness of some wireless communication system policies, it has been recognised that some spectrum resources have been under-utilised, such as TV white band. These temporal and/or spatial unoccupied spectrum resources can be viewed as spectral opportunities and exploited by other wireless communication system to improve their throughput besides working on their own subscribed spectrum.

In this paper, the proposed communication strategy uses both licensed (subscribed) and unlicensed (opportunistic) spectrum resources for transmission, while the former one will be used to provide a minimum service and the latter one will be used to expand the CPS communication performance. Note that the subscribed spectrum is not limited to the spectrum bandwidth which has been only purchased for exclusive usage, where free ISM bands can be also used as subscribed spectrum. The difference between the subscribed spectrum and opportunistic spectrum is whether the smart grid communication system is the primary user.

A central spectrum coordination module will perform the real-time spectrum sensing to identify the spectral opportunities. The state-of-the-art spectrum sensing method is able to simultaneously detect the spectrum usage in a wide range [18]. Then the available channels will be allocated to the nodes with transmission requirement.

### 2.3 Categories of smart grid applications

Integrating advance communication techniques into power grid has enabled many new applications, such as smart meters, demand management and real-time voltage stability enhancement. As can be foreseen, many more kinds of smart grid application will emerge in the near future. Different from the cellular network and other data-oriented network, the information transmitted via smart grid CPS communication network are essentially physical devices oriented. Due to the various needs, functions and algorithms, the data to be exchanged within the smart grid CPS are usually of different types, which will have different time performance requirements. For example, billing information are usually time insensitive, where a relatively long delay will not impair its performance. However, for typical real-time applications, the

**Table 1** Categories of smart grid applications

Class number	Information type	Occurrence probability	Delay tolerance	Throughput requirement	Importance
1	informative	high	high	high	low
2	important	medium	medium	medium	medium
3	critical	low	low	low	high

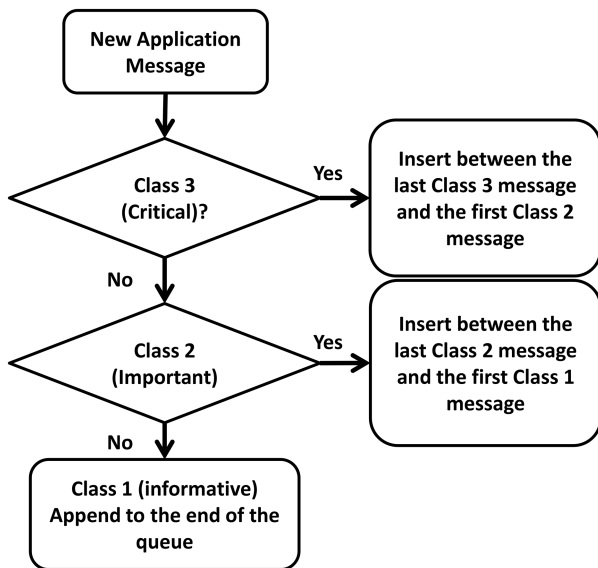
**Fig. 3** Nodes queue strategy diagram

measured status at the physical sensors usually changes with time, while the control decision should be delivered to corresponding actuators as soon as possible, because these kinds of information are only valid for a very short period of time. In order to provide better services to different applications, the information of different applications can be categorised into three general classes, namely critical information, important information and informative information, which are summarised in Table 1 and detailed as follows.

**2.3.1 Informative information (Class 1):** All latency insensitive applications can be categorised as informative information class, such as smart metering, billing information and other information gathering applications. Compared to the critical information and important information classes, messages in informative information class are relatively frequently generated. The messages in this class usually require high throughput, but a significant delay might not compromise the performance.

**2.3.2 Important information (Class 2):** For most real-time applications, such as voltage stability enhancement, demand response and supervisory control and data acquisition, they can be categorised as important information. Based on different mechanisms and algorithms, the messages associated to important information class can be event-driven or periodic generated. The messages can be measurements or control commands. Latency will usually result in a compromised performance.

**2.3.3 Critical information (Class 3):** Critical information has the highest priority among all the information classes. Applications require strictly low latency or vital information that has to be transmitted immediately should be categorised into this class. The common features of this kind of information are: (a) rare in occurrence and (b) short in message length. However, latency for this kind of information will result in serious consequences. Typical applications include grid control commands, outage detection and restoration and other vital messages for control, protection and management.

### 3 Proposed communication strategy and performance analysis

As discussed in Section 2.3, the applications in smart grid CPS can be categorised into three general classes. For applications with critical information and important information, time performance is the most concerned quality of service requirement, while the applications with informative information are insensitive to even a very large latency. Based on these important features, the communication strategy can be designed accordingly as detailed below.

#### 3.1 Queue strategy for messages in each CPS communication node

For each node in the smart grid CPS communication network, all new arrival messages queue by the following rules:

- Between different classes, the new arrival message queue after all the messages with higher class priority.
- Within the same class, the new arrival message follows first come first serve method, i.e. queue at the end of the same class messages.

A detailed diagram for the nodes queue strategy is given in Fig. 3.

#### 3.2 Channel allocation strategy

The temporal and spatial unexploited spectrum is sensed and allocated by the central spectrum coordination centre. In this paper, the total available spectrum resources consist of two parts, the subscribed spectrum and opportunistic spectrum. For a transmission round, the central spectrum coordination centre will perform the spectrum sensing first to obtain the current spectrum availability status. Then the spectrum will be divided into several sub-channels and allocated to the nodes based on the following rules:

- Nodes with higher priority message are allocated to a channel before nodes with lower priority message.
- Nodes with same priority message are allocated randomly to ensure a long term fairness.

A detailed diagram for the channel allocation strategy is given in Fig. 4. The spectrum sensing is performed by the spectrum coordination module located at the control centre. Here we consider the widely applied energy detection spectrum sensing method [1], which periodically monitors the opportunistic spectrum bands and compares the signal strength to a decision threshold. Note that in this paper three message priority classes have been considered, hence only three channel allocation iterations have been implemented.

#### 3.3 Long-term performance analysis

In this part, we will analyse the long-term performance of the proposed communication strategy.

It is assumed that there are  $N$  communication nodes in the smart grid CPS communication network, which are labelled as Node <sub>$k$</sub> , where  $k = 1, \dots, N$ . Let  $A_j^{(i)}$  denotes the  $j$ th application in information class  $i$ , where  $i = 1, 2, 3$  and  $j = 1, \dots, N_i$ . The average probability for the application  $A_j^{(i)}$  generating one message during one second is denoted by  $p_j^{(i)}$ , while the average size of the messages is  $M_j^{(i)}$  bits. If Node <sub>$k$</sub>  will receive and send messages of

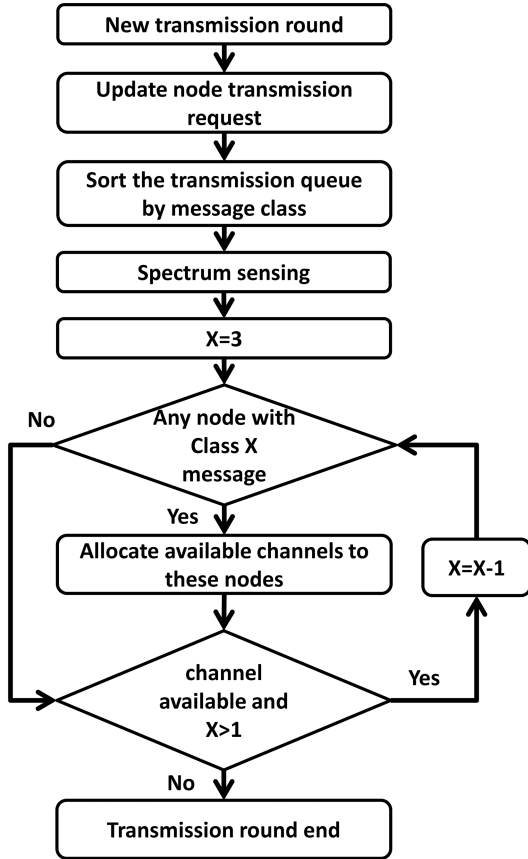

Fig. 4 Channel allocation strategy diagram

application  $A_j^{(i)}$ , then the  $k$ th element  $w_k = 1$  in the application indicator vector  $\mathbf{W}_j^{(i)} = [w_1, \dots, w_N]$ , or  $w_k = 0$  otherwise.

For application of class  $i$ , the expected total message volume within the network during one second can be given by

$$M_C^{(i)} = \sum_{j=1}^{N_i} \mathbf{W}_j^{(i)} \mathbf{1}_N^T P_j^{(i)} M_j^{(i)}, \quad (1)$$

where  $\mathbf{1}_N$  is the all one vector of length  $N$  and the symbol  $(\cdot)^T$  denotes transpose operation.

The bandwidths for the subscribed spectrum and opportunistic spectrum are denoted by  $B_{\text{sub}}$  and  $B_{\text{opp}}^{(m)}$ , Hz, while the average signal-to-noise ratio (SNR) are  $\text{SNR}_{\text{sub}}$  and  $\text{SNR}_{\text{opp}}^{(m)}$ , where  $m = 1, \dots, N_{\text{opp}}$  and  $N_{\text{opp}}$  is the total number of spectral bands to be opportunistic exploited. Using Shannon capacity theory, the long term equivalent throughput for the subscribed spectrum band can be given by [19]

$$\Theta_{\text{sub}} = B_{\text{sub}} \log_2(1 + \text{SNR}_{\text{sub}}), \quad (2)$$

For opportunistic spectrum bands, the communication system is using these spectrum bands as second user and should avoid the interference to the primary user. The probability of appearance for the primary user in spectrum band  $m$  is assumed to be  $p_{\text{PR}}^{(m)}$ . When the primary user appears at the spectrum band  $m$ , the communication system should yield to the primary user and use other vacant spectrum bands. Besides, there are possibilities that the spectrum sensing algorithms fail to detect the spectrum availability and a false detection of primary user's appearance. In these two cases, the opportunistic spectrum band will also not be used for transmission. For the opportunistic spectrum band  $m$ , if we denote the probability of detection and false alarm by  $p_d^{(m)}$  and  $p_f^{(m)}$ , then the long term equivalent throughput can be given by

$$\Theta_{\text{opp}}^{(m)} = p_d^{(m)}(1 - p_f^{(m)})(1 - p_{\text{PR}}^{(m)})B_{\text{opp}}^{(m)} \log_2(1 + \text{SNR}_{\text{opp}}^{(m)}) \quad (3)$$

**3.3.1 Network saturation:** From the queuing theory aspect, the service rate of the system should be larger or at least equivalent to the arrival rate of the applications to avoid the system queue length from growing to infinite [20]. In the considered CPS communication network, it corresponds to the requirement of communication throughput should be no less than the rate of new arrival messages. If we define the network saturation metric as  $S = \Theta/M$ , then  $S = 1$  will be the saturation point, which means that the arrival rate of new messages is the same with the service rate of CPS communication network. If  $S < 1$ , then the messages at each communication node will surely to queue up, which will finally result in communication failure. Generally speaking, the larger  $S$  means less probability of message queueing up and more redundancy of communication capability. This will be important in both provide performance guarantee for existing applications and allow spaces for further upcoming new applications. The network saturation metric  $S_{\text{sub}}$  for the situations where only subscribed spectrum is used can be given by

$$S_{\text{sub}} = \frac{\Theta_{\text{sub}}}{\sum_{i=1}^3 M_C^{(i)}} \equiv \frac{\Theta_{\text{sub}}}{\sum_{i=1}^3 \sum_{j=1}^{N_i} \mathbf{W}_j^{(i)} \mathbf{1}_N^T P_j^{(i)} M_j^{(i)}}, \quad (4)$$

while  $S_{\text{opp+sub}}$  for the situation where both subscribed spectrum and opportunistic spectrum are used can be given by

$$S_{\text{opp+sub}} = \frac{\Theta_{\text{sub}} + \Theta_{\text{opp}}}{\sum_{i=1}^3 M_C^{(i)}} \equiv \frac{\Theta_{\text{sub}} + \Theta_{\text{opp}}}{\sum_{i=1}^3 \sum_{j=1}^{N_i} \mathbf{W}_j^{(i)} \mathbf{1}_N^T P_j^{(i)} M_j^{(i)}} \quad (5)$$

Compared to the networks only using the subscribed spectrum, more applications can be served by exploiting spectrum sharing techniques. Moreover, for the same application setups, the packages on each CPS node is less likely to queue up. The network saturation performance gain can be given by

$$\frac{S_{\text{opp+sub}}}{S_{\text{sub}}} = 1 + \frac{\Theta_{\text{opp}}}{\Theta_{\text{sub}}}. \quad (6)$$

This gain indicates that the throughput improvement for the smart grid CPS will depend on the ratio of opportunistic spectrum and the subscribed one. It worth mention that the available bandwidths for opportunistic spectrum bands are usually far more larger than the subscribed spectrum bands. Actually in theory any unoccupied spectrum can be exploited for transmission.

**3.3.2 Expected longest latency:** For the smart grid communication networks, the performance for most real-time applications is decided by the last arrived message. Here we consider the expected longest latency  $D_i$  defined as the time experience by the last transmitted message in the class  $i$ . Then with the proposed channel allocation strategy based on application class priority, we have

$$D_i = \frac{\sum_{n=1}^i M_C^{(A-n)}}{\Theta_{\text{sub}} + \Theta_{\text{opp}}} \quad (7)$$

while for the strategies without application class priority, we have

$$D'_1 = D'_2 = D'_3 = \frac{\sum_{n=1}^3 M_C^{(n)}}{3(\Theta_{\text{sub}} + \Theta_{\text{opp}})} \quad (8)$$

Due to the nature of the information in each class, we usually have  $M_1 > M_2 > M_3$ . Hence we have  $D_3 < D'_3$ , which means that the critical applications in Class 3 will experience less waiting time compared to the strategies without application class priority.

Also we have

$$D_2 - D'_2 = \frac{2M_C^{(3)} + 2M_C^{(2)} - M_C^{(1)}}{3(\Theta_{\text{sub}} + \Theta_{\text{opp}})}.$$

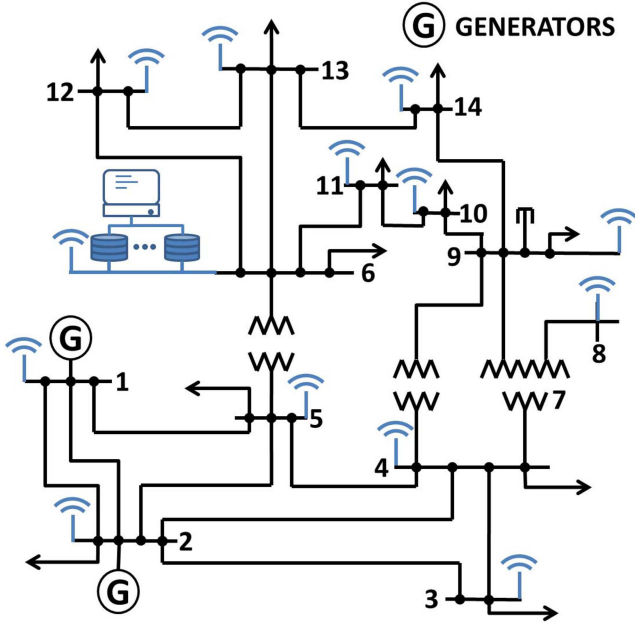

Fig. 5 IEEE 14-bus diagram [21]

If we assume that the application in Class 3 have relatively extremely low probability in generating messages, then the average size of the messages  $M_C^{(3)} \approx 0$ . In this case, the condition for  $D_2 < D_2'$  can be estimated by  $M_C^{(1)} > 2M_C^{(2)}$ . It can be expected that the applications in Class 2 will also experience less waiting time compared to the strategies without application class priority, if the average size of the messages generated by Class 1 is more than the double of that by Class 2. Note that this condition is easy to be satisfied, since metering applications in Class 1 usually generate large volume of messages [3].

#### 4 Case study

In this section, we will use the IEEE 14-bus system to test the performance of the proposed communication strategy, which is illustrated in Fig. 5.

It is assumed that the transmission nodes are allocated at each bus position while the control centre with spectrum coordination module is located at bus 6. All nodes will receive and send messages from all applications. In addition, it is assumed that all applications within same class have same probability of generating one message during one unit time, which are  $p_j^{(1)} = 0.2$ ,  $p_j^{(2)} = 0.1$ , and  $p_j^{(3)} = 0.01$ . There is only one Class 3 application in all simulations, while there are multiple applications in both classes 1 and 2. Also an average package size for the message of different classes are assumed to be  $M_j^{(1)} = 4$  kbits,  $M_j^{(2)} = 2$  kbits and  $M_j^{(3)} = 1$  kbits.

In order to test the performance of the proposed communication strategy on certain applications, one typical Class 2 application, namely real-time voltage stability enhancement, has been implemented within IEEE 14-bus system via reactive power compensation at buses 2–14. This will be detailed in Section 4.1.

##### 4.1 Real-time voltage stability enhancement

Voltage stability is one of the major concerns to the secure and reliable operation of the power grid. The loss of voltage stability will result in a shorten life of electronic components, cascading outages or even wide-range blackouts. However, due to transmission loss and varying load, the voltage on different buses will change in a real-time manner. Real-time voltage stability enhancement is an application that intends to help keep the voltages close to the nominal values and enhance the stability of the power grid, which is introduced as follows.

For illustration purpose, an IEEE 14-bus power system has been considered as given in Fig. 5. It is assumed that a traditional power

plant is located at bus 1, while a wind farm is located at bus 2. Static Volt-Ampere reactive compensators (SVCs) are installed on each load bus. Meanwhile, in order to estimate the voltage stability, the metric of  $L$ -index is introduced, which is a linear voltage stability indicator for load buses. The  $L$ -index can be computed as [22]

$$L_j = \left| 1 - \sum_{i=1}^g F_{ji} \frac{V_i}{V_j} \right|, \quad (9)$$

where  $V_i$  and  $V_j$  are the voltages at load buses and generator buses, respectively, where  $i = 1, \dots, g$  are the generator bus numbers and  $j = 1, \dots, \ell$  are the load bus numbers.  $F_{ji}$  in (9) is the element of the  $F_{\ell g}$  matrix which is computed from admittance matrix. To be specific, according to circuit theory we have the relation between current, voltage and admittance as follows:

$$\begin{bmatrix} I_g \\ I_\ell \end{bmatrix} = \begin{bmatrix} Y_{gg} & Y_{g\ell} \\ Y_{\ell g} & Y_{\ell\ell} \end{bmatrix} \begin{bmatrix} V_g \\ V_\ell \end{bmatrix}, \quad (10)$$

where  $Y_{\ell\ell}$  is the self-admittance at the bus  $\ell$ ,  $Y_{\ell g}$  is the mutual admittances between the buses  $\ell$  and  $g$  and similar notation rules apply to  $Y_{gg}$  and  $Y_{g\ell}$ . By rearranging (10), we have

$$\begin{bmatrix} V_\ell \\ I_g \end{bmatrix} = \begin{bmatrix} Z_{\ell\ell} & F_{\ell g} \\ K_{g\ell} & N_{gg} \end{bmatrix} \begin{bmatrix} I_\ell \\ V_g \end{bmatrix}, \quad (11)$$

where  $F_{\ell g}$  can be computed as  $F_{\ell g} = -Y_{\ell\ell}^{-1}Y_{\ell g}$ . Applying similar rules, the matrices  $Z_{\ell\ell}$ ,  $K_{g\ell}$  and  $N_{gg}$  can be obtained.

For a specific power grid, the elements of admittance matrices  $Y_{\ell g}$  and  $Y_{\ell\ell}$  are readily available. These parameters can be viewed as constant unless there are changes to the grid topology. Although there are matrix manipulations involved in the calculation of  $F_{\ell g}$ , it only needs to be calculated once and can be viewed as a prior knowledge thereafter. Besides, bus voltages are necessary information for power grid operation, which can be obtained via numerical power flow methods such as Newton–Raphson power flow solution. Therefore the calculation of  $L$ -index defined in (9) will not introduce significant extra computation complexity to the system.

The  $L$ -index  $L_j$  given in (9) indicates the distance between operation point and the condition of no load. For individual buses, the  $L$ -index is strictly within the range of 0 to 1, namely  $0 \leq L_j \leq 1$ . If there is no load connected to that bus, then  $L_j = 0$ . For the extreme condition with significant load increase in the power system, the  $L$ -index  $L_j$  will be inherently increased to 1, which indicates the power system is at its maximum power transfer condition and reaches the collapse point. Generally speaking, smaller  $L$ -index value means the allowance for the increase of load is larger, which is corresponding to the more stable status of this bus.

It is an effective way to reduce line currents and network losses by injecting reactive power into the power system, which in turn helps to keep the voltages close to the nominal values and enhance the stability. Therefore, reactive power compensation is widely applied to improve the voltage stability margins. Due to the rotor current injection schemes, the reactive power output can also be controlled. Hence it is feasible to control wind generators as the sources of reactive power. Here we denote the reactive power output of SVCs and wind generators as  $Q_{svc}$  and  $Q_{wg}$ , respectively.

The improvement of voltage stability for the whole power grid system can be formulated as minimising the sum of the squares of  $L$ -index values at all load buses. Hence the optimisation formulation can be defined by combining the objective function and the associated constraints, as follows:

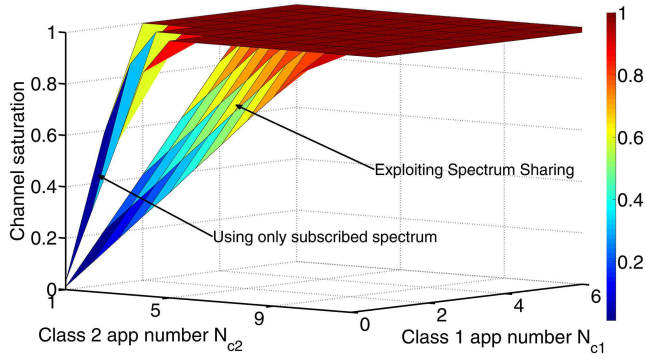

**Fig. 6** Channel saturation with different application numbers under two scenarios

(a) Using only subscribed spectrum, (b) Exploiting spectrum sharing

$$\begin{aligned} \min T(\mathbf{Q}) &= \sum_{j=1}^{\ell} L_j^2 \\ \text{s. t. } \mathbf{Q}_{\text{wg}}^{\min} &\leq \mathbf{Q}_{\text{wg}} \leq \mathbf{Q}_{\text{wg}}^{\max} \\ \mathbf{Q}_{\text{svc}}^{\min} &\leq \mathbf{Q}_{\text{svc}} \leq \mathbf{Q}_{\text{svc}}^{\max} \end{aligned} \quad (12)$$

where  $\mathbf{Q}$  is the control variable including  $\mathbf{Q}_{\text{svc}}$  and  $\mathbf{Q}_{\text{wg}}$ .

In the case study, the real-time voltage stability enhancement application will collect the bus power status, and then make the reactive power compensation every one second. The measurements and control decisions will be transmitted via the proposed communication strategy. To be specific, the power flow measurements including active power and reactive power will be taken at each bus. Then this information will be transmitted to the control centre at bus 6 via the communication nodes installed at each bus as illustrated in Fig. 5. These nodes may also transmit the information from other applications, and their channel assignments follow the proposed communication strategy. After receiving all the power flow measurements, the control centre will make reactive compensation decisions to improve the overall grid voltage stability via (12). These reactive compensation decisions will be delivered to individual buses for actuation via the proposed communication strategies.

#### 4.2 Simulation and discussion

It is assumed that the smart grid communication system has a total bandwidth of 40 MHz as subscribed user. The subscribed bandwidth is divided into five sub-channels, and each sub-channel has the same bandwidth of 8 MHz. Here we consider TV white space frequency band in 470–550 MHz, which consists of ten sub-channels of 8 MHz bandwidth each [23]. The probability of the primary user occupying the TV white space is assumed to be  $p_{\text{PR}} = 0.1$ , while  $p_d$  and  $p_f$  are both assumed to be 0. The average SNRs for all channels are assumed to be 3, while the Nakagami- $m$  fading with the parameter  $m=2$  has been considered for each channel. Without loss of generality, each transmission round is assumed to be 1 ms, where the first 0.5 ms is for the down-link (from central control centre to nodes) transmission and the second 0.5 ms is for the up-link (from nodes to central control centre) transmission.

In order to verify the effectiveness of the proposed class priority-based communication strategy, two strategies without considering class priority have been used as comparisons, which apply the first come first serve (FCFS) method and throughput-

oriented method [24]. To be specific, in the FCFS method, the available channel will be assigned to the first requesting node. On the other hand, in throughput-oriented method, the channel will be assigned to the node with maximum achievable throughput.

As can be seen in Fig. 6, by exploiting opportunistic spectrum, the smart grid cyber-physical communication system can support more applications before reaching the saturation status than that of using only the subscribed spectrum. Under the unsaturated scenarios with same application setups, spectrum sharing-based system can provide more communication capacity redundancy. The capacity surplus is important in both leaving spaces for future applications as well as allowing various choices of advanced communication techniques. Note that in this simulation, only part of the TV white spectrum has been considered. By 2022, a total of 750 MHz spectrum sharing resources in the below 10 GHz bands will become available [23]. Furthermore, the essence of spectrum sharing method is to take advantage of unexploited spectrum resources, whether it is temporal, spatial or from other dimension aspect. Hence it can be expected that the communication capacity of smart grid CPS can be further expanded.

In order to test the time performance of both time sensitive and insensitive applications, two scenarios have been considered. The first has three Class 1 applications, three Class 2 applications and one Class 3 application, while the second one has three Class 1 applications, four Class 2 applications and one Class 3 application. The results have been summarised in Tables 2 and 3. It can be indicated from both tables that average and maximum transmission time for Class 3 application packages have been improved with the implementation of application class priority. Furthermore, by comparing two tables, when more applications are simultaneously served, the time performances for Class 3 applications do not compromise as the FCFS and throughput oriented strategies do, which are all without the consideration of application class priority. This feature will be important in guaranteeing the time performance of the application with vital information. Due to the application class priority, time performance for Class 2 applications have also been improved, which is at the cost of increasing the transmission time of Class 1 applications as expected from the analysis in Section 3.3.2. As the channel usage getting close to saturation, the time performance for Class 1 applications will be further compromised. However, as the Class 1 applications are insensitive to latencies, the overall system performance has been improved. It should also be noted that, without the spectrum resources provided by the spectrum sharing technology, the channel will be easily saturated by various Class 1 applications and the proposed priority-based communication strategy will not have the similar good performance. Besides, it can be also indicated from Tables 2 and 3 that, from the aspect of time performance, throughput oriented method has similar performance with the FCFS method.

The voltage stability performance of IEEE 14-bus system has been given in Fig. 7. Since timely VAR compensation has been made with real-time varying grid power flow measurement, the overall voltage stability performance has been largely improved. This is true for situations of both with and without communication delays, as well as with and without the consideration of class priorities. However, it can be also told from Fig. 7 that communication delay will impair the compensation outcome. This is due to the fact that the control decision is made based on the lagged measurements, which will then also experience latency due to the communication delay. It is indicated from Fig. 7 that, by applying the proposed transmission strategy with class priority, the overall voltage stability is the most close one to the best achievable performance, which is due to the reduced latency for real-time

**Table 2** Time performance with three Class 1 applications, three Class 2 applications and one Class 3 application

Class number	Class 1		Class 2		Class 3	
	Average, ms	Max, ms	Average, ms	Max, ms	Average, ms	Max, ms
proposed class priority method	0.74	17.50	0.25	4.25	0.13	0.13
FCFS method	0.68	15.50	0.44	7.25	0.32	2.13
throughput oriented method	0.67	14.50	0.43	8.25	0.31	2.13

**Table 3** Time performance with three Class 1 applications, four Class 2 applications and one Class 3 application

Class Number	Class 1		Class 2		Class 3	
	Average, ms	Max, ms	Average, ms	Max, ms	Average, ms	Max, ms
proposed class priority method	1.23	29.50	0.26	5.25	0.13	0.13
FCFS method	0.98	20.50	0.75	14.25	0.64	3.13
throughput oriented method	0.97	21.50	0.73	15.25	0.61	3.13

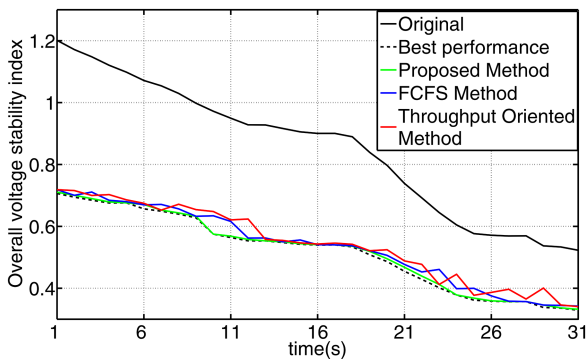
**Fig. 7** Performance of voltage stability enhancement application

applications. It can be noticed that the real-time voltage stability enhancement application has similar overall performance using FCFS method and throughput oriented method. When applying methods without considering class priority such as FCFS method and throughput oriented method, the voltage stability performance is more likely to be compromised if the bus loads have relatively larger changes, which is indicated during the periods of 6–15 and 18–31 s in Fig. 7. By applying the proposed transmission strategy with class priority, the overall voltage stability is more close to best performance than those without considering class priority, which is due to the reduced latency for real-time applications. If the considered power grid becomes larger and more applications are involved in the communication network, the influence of communication latency will be more prominent.

## 5 Conclusion

In this paper, the applications in smart grid CPSs have been briefly reviewed and categorised into three classes, namely critical information, important information and informative information. Based on the properties and features of this classification, a communication strategy has been proposed. The long-term performance for the proposed strategy has been analysed and discussed. A case study of IEEE 14-bus power system has been performed, where the application of real-time voltage stability has been considered. In addition, simulation under several scenarios has been carried out. Results have shown that, via the implementation of the proposed application class priority-based communication strategy, the throughput and real-time performance of spectrum sharing enabled smart grid CPS have been improved.

## 6 References

- [1] Khan, A.A., Rehmani, M.H., Reisslein, M.: 'Cognitive radio for smart grids: survey of architectures, spectrum sensing mechanisms, and networking protocols', *IEEE Commun. Surv. Tutor.*, 2016, **18**, (1), pp. 860–898
- [2] Yu, X., Xue, Y.: 'Smart grids: a cyber-physical systems perspective', *Proc. IEEE*, 2016, **104**, (5), pp. 1058–1070
- [3] Kabalci, Y.: 'A survey on smart metering and smart grid communication', *Renew. Sustain. Energy Rev.*, 2016, **57**, pp. 302–318
- [4] Moradi-Pari, E., Nasiriani, N., Fallah, Y.P., *et al.*: 'Design, modeling, and simulation of on-demand communication mechanisms for cyber-physical energy systems', *IEEE Trans. Ind. Inf.*, 2014, **10**, (4), pp. 2330–2339
- [5] Georg, H., Müller, S.C., Rehtanz, C., *et al.*: 'Analyzing cyber-physical energy systems: the INSPIRE cosimulation of power and ICT systems using HLA', *IEEE Trans. Ind. Inf.*, 2014, **10**, (4), pp. 2364–2373
- [6] The Office of Communications: 'Award of the 800 MHz and 2.6 GHz spectrum bands-publication of final results of auction under regulation 111 of the wireless telegraphy (licence award) regulations 2012'. 2016, Available at: [https://www.ofcom.org.uk/\\_data/assets/pdf\\_file/0031/74893/4g-final-results.pdf](https://www.ofcom.org.uk/_data/assets/pdf_file/0031/74893/4g-final-results.pdf)
- [7] The Office of Communications: 'A framework for spectrum sharing'. 2016, Available at: [https://www.ofcom.org.uk/\\_data/assets/pdf\\_file/0032/79385/spectrumsharing-framework.pdf](https://www.ofcom.org.uk/_data/assets/pdf_file/0032/79385/spectrumsharing-framework.pdf)
- [8] Pop, P., Raagaard, M.L., Craciunas, S.S., *et al.*: 'Design optimisation of cyber-physical distributed systems using IEEE time-sensitive networks', *IET Cyber-Phys. Syst., Theory Appl.*, 2017, **1**, (1), pp. 86–94
- [9] Cao, X., Liu, L., Shen, W., *et al.*: 'Real-time misbehavior detection and mitigation in cyber-physical systems over WLANs', *IEEE Trans. Ind. Inf.*, 2017, **13**, (1), pp. 186–197
- [10] Viegas, R.Jr., Guedes, L.A., Vasques, F., *et al.*: 'A new MAC scheme specifically suited for real-time industrial communication based on IEEE 802.11e', *Comput. Electr. Eng.*, 2013, **39**, (6), pp. 1684–1704, Available at: <http://www.sciencedirect.com/science/article/pii/S0045790612001929>
- [11] Cena, G., Seno, L., Valenzano, A., *et al.*: 'On the performance of IEEE 802.11e wireless infrastructures for soft-real-time industrial applications', *IEEE Trans. Ind. Inf.*, 2010, **6**, (3), pp. 425–437
- [12] Cintuglu, M.H., Mohammed, O.A., Akkaya, K., *et al.*: 'A survey on smart grid cyber-physical system testbeds', *IEEE Commun. Surv. Tutor.*, 2017, **19**, (1), pp. 446–464
- [13] Atat, R., Liu, L., Chen, H., *et al.*: 'Enabling cyber-physical communication in 5G cellular networks: challenges, spatial spectrum sensing, and cyber-security', *IET Cyber-Phys. Syst., Theory Appl.*, 2017, **2**, (1), pp. 49–54
- [14] Feng, Z., Li, Q., Li, W., *et al.*: 'Priority-based dynamic spectrum management in a smart grid network environment', *IEEE J. Sel. Areas Commun.*, 2015, **33**, (5), pp. 933–945
- [15] Huang, J., Wang, H., Qian, Y., *et al.*: 'Priority-based traffic scheduling and utility optimization for cognitive radio communication infrastructure-based smart grid', *IEEE Trans. Smart Grid*, 2013, **4**, (1), pp. 78–86
- [16] Lee, E.A., Seshia, S.A.: 'Introduction to embedded systems: a cyber-physical systems approach' (Lee & Seshia, 2011)
- [17] Gunes, V., Peter, S., Givargis, T., *et al.*: 'A survey on concepts, applications, and challenges in cyber-physical systems', *KSI Trans. Internet Inf. Syst.*, 2014, **8**, (12), pp. 4242–4268
- [18] Jiang, J., Sun, H., Baglee, D., *et al.*: 'Achieving autonomous compressive spectrum sensing for cognitive radios', *IEEE Trans. Veh. Technol.*, 2016, **65**, (3), pp. 1281–1291
- [19] Shannon, C.E.: 'A mathematical theory of communication', *ACM Sigmoid. Mob. Comput. Commun. Rev.*, 2001, **5**, (1), pp. 3–55
- [20] Rappaport, T.S.: 'Wireless communications: principles and practice', vol. 2, (Prentice-Hall, PTR New Jersey, 1996)
- [21] IEEE 14 bus power flow test case. Available at: [https://www2.ee.washington.edu/research/pstca/pf14/pg\\_tca14bus.htm](https://www2.ee.washington.edu/research/pstca/pf14/pg_tca14bus.htm)
- [22] Kumar, V.S.S., Reddy, K.K., Thukaram, D.: 'Coordination of reactive power in grid-connected wind farms for voltage stability enhancement', *IEEE Trans. Power Syst.*, 2014, **29**, (5), pp. 2381–2390
- [23] The Office of Communications: 'The wireless telegraphy (white space devices) regulations 2015'. Available at: [http://www.legislation.gov.uk/uksi/2015/2066/pdfs/ukxi\\_20152066\\_en.pdf](http://www.legislation.gov.uk/uksi/2015/2066/pdfs/ukxi_20152066_en.pdf)
- [24] Salameh, H. A.B.: 'Throughput-oriented channel assignment for opportunistic spectrum access networks', *Math. Comput. Model.*, 2011, **53**, (11), pp. 2108–2118